

Bearings

Miniature Precision Ball Bearings

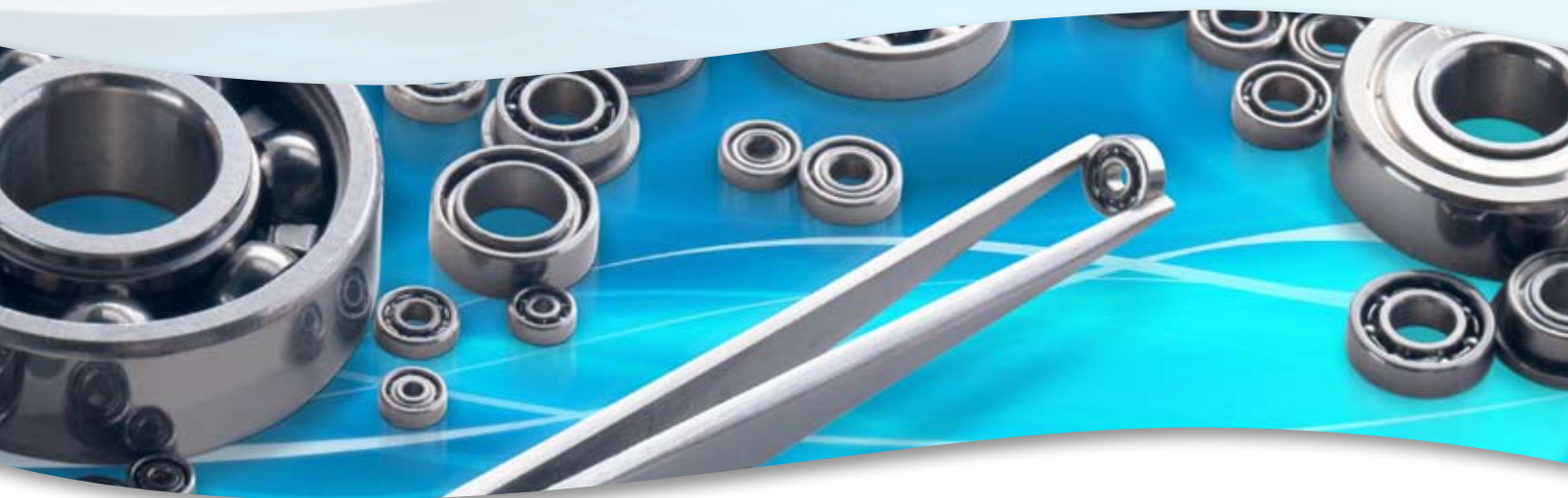

The logo features a grey arc with a blue sphere at its right end, positioned above the text.
NMBTM
Minebea

NMB Technologies Corporation



NMB Technologies Corporation is a subsidiary of NMB (USA) Inc., the North American headquarters and operating center of the Minebea Group of Companies. Minebea Co., Ltd., was established in 1951 as Japan's first specialized manufacturer of miniature ball bearings.

Today, the Company is the world's leading comprehensive manufacturer of miniature ball bearings and high precision components, supplying customers worldwide in the information and telecommunications equipment industry, as well as aerospace, automotive and household electrical appliance industry.

The Minebea Group consists of 43 subsidiaries and affiliates in 16 countries, including Japan, Thailand, China and Singapore as well as several others in Europe and the Americas. The Group maintains 30 plants and 37 sales offices, and employs approximately 55,000 people worldwide.

NMB offers a comprehensive line of bearings ranging in size from .1181 to 1.000 inch O.D. (3mm to 26mm), available in inch and metric sizes. Stainless steel or chrome steel bearings are available with crown or ribbon

type metallic cages, as well as plastic crown type cages. NMB bearings are found in medical equipment, advanced automotive applications and household electrical appliances such as air conditioners, vacuum cleaners, VCRs and video cameras, and in motors for electronic controls systems, among others.

NMB Technologies Corporation's domestic headquarters are located in Chatsworth, California. Highly trained application engineers, experienced product managers and customer service representatives work closely with customers to develop the most cost effective solution for today's challenging applications. Pre-design and after-delivery follow up assure complete customer satisfaction.

Contact NMB Technologies Corporation today. Visit our web site at www.nmbtc.com or call our Bearings Product Group directly at 818-341-3355.



Table of Contents



Section 1	
Basic Information	1.1 - 1.14
Section 2	
Inch Series Bearings	2.1 - 2.8
Section 3	
Inch Series Bearings	3.1 - 3.6
Section 4	
Engineering Information	4.1 - 4.23



Modern Facilities For The Highest Quality Volume Production.



NMB Technologies Corporation's automated plants in Asia are among the most modern production facilities in the world. Their ability to turn out millions of bearings of the highest quality at competitive costs every month has helped to make the company the world's leading manufacturer of miniature and instrument ball bearings.

Dedication and commitment to the continuous improvement of manufacturing processes requires a significant investment of corporate resources in a wide range of technical disciplines, including statistical process control, correlation of instrumentation, and the relation

of initial design parameters to specific applications. It also requires the implementation of these advanced technologies, and their application, to every phase of parts processing, bearing assembly and inspection.

The integrity of all bearings and related products is further assured by the most advanced test equipment housed in environmentally controlled "white rooms." The most advanced performance and reliability testing equipment is on-line in the same clean room facilities that house bearing assembly operations.

Advanced Production Technologies and Consistent Quality.



The correlation of gages and gaging methods is performed by NMB at regular intervals to assure that products meet or exceed all documented specifications.

NMB also counts on extensive research, development and tool making facilities. Material laboratories are equipped and staffed to perform full chemical, metallurgical and visual analysis of bearing components.

Process surveillance is maintained on all production operations to ensure that each and every bearing produced is of the highest quality.

The effective utilization of these resources has allowed NMB to supply customers with bearings of the highest quality and provide them with the most thorough after-sale service.



Basic Information

This section covers both the basic technical information governing bearing selection and the part numbering system used in this catalog. When the part numbering is different from the basic system, that particular numbering is described in the pertinent section. The various ball bearing parts and components referred to in this catalog are illustrated with brief descriptions, the basic dimensional symbols shown are defined.

Basic Technical Information.....	1.1 - 1.3
Ball Bearing Components.....	1.4
Basic Dimension Data.....	1.5
Part Numbering System	1.6 - 1.9
Index	1.10 - 1.13
Ultra-Precision Machining Technology.....	1.14



Basic Technical Information

Bearing Selection

There are several important considerations which must be evaluated simultaneously when choosing the proper bearing for a particular device. A detailed analysis of these considerations may be found in the Engineering Section; we will, however, briefly discuss some of the more important ones here.

Miniature and instrument ball bearings are normally made of either Stainless Steel or Chrome Alloy Steel. Life calculations are affected by bearing material hardness as well as lubrication selection. These issues are discussed further beginning on page 4.12.

ABEC Grade

Factors to be considered in selecting the ABEC Grade required for a bearing are Bore and O.D. fits, radial and axial runout requirements, and cost. The table below shows Bore and O.D. radial runout limits and size tolerances vs. ABEC Grade.

ABEC GRADE	MAXIMUM RADIAL RUNOUT		MEAN DIAMETER TOLERANCE		
	INNER RING	OUTER RING	BORE	O.D.	O.D.SIZE
1	.0003	.0006	+0.000 -0.0003	+0.000 -0.0003 +0.000 -0.00035	0-18mm over 18-30mm
3	.0002	.0004	+0.000 -0.0002	+0.000 -0.0003	0-30mm
5	.00015	.0002	+0.000 -0.0002	+0.000 -0.0002	0-30mm
7	.0001	.00015	+0.000 -0.0002	+0.000 -0.0002	0-30mm

The chart on page 4.18 gives a more complete description of the tolerances controlled by the ABEC. Note: All miniature and instrument bearings of both the metric and inch configurations meet the tolerances of ABMA Standard 20 for ABEC 1 metric series bearings.

Type of Cage

The two types of pressed steel ball cages are available for most bearings. "H" or metallic crown type, and "R" or two piece metallic ribbon type.



These two cage types are interchangeable in most common applications.

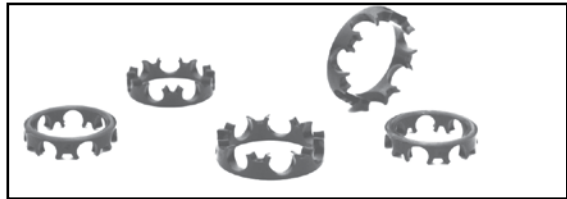

Also available for some sizes are cages made of molded and machined plastics. Our engineers can provide recommendations for any special requirements.

Shields and Seals

Shields are available for most sizes, as shown on the listing pages. These closures will help to reduce the entrance of particulate contaminants into the bearing and will reduce the amount of lubricant leakage. Radial clearance between the shield bore and the inner ring O.D. is approximately .002 to .005 inch. The effect of shields on bearing torque or noise is insignificant.

Contacting seals made of synthetic rubber (DD) are available for most sizes. These seals provide the best protection from the entrance of contaminants, or exit of lubricant, but as a result, significantly increase operating torque. (DD) seals will withstand a slight amount of positive pressure differential.

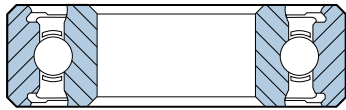

(DD)

Non contacting seals made of synthetic rubber (SS), or reinforced PTFE (LL), are also available for most chassis sizes. This type of seal offers better sealing than a metal shield, while keeping operating torque at the lowest possible levels. (LL) seals will contact the inner ring in some cases, but the nature of the seal material serves to keep torque at a minimum.

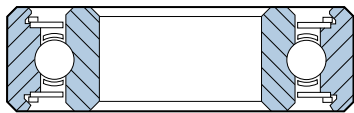

(LL)

Radial Play

Radial play is the free internal radial looseness between the balls and races. Radial play within a ball bearing is necessary to accommodate thermal expansions, the effects of interference fit, and to control axial play. In cases of extreme temperature, speed, load, or where axial play amount is important, our Engineering Department should be consulted for recommendations.

Starting & Running Torque

The operating torque of a bearing can be described as starting and running torque. Starting torque is the force required to begin rotation from a bearing at rest. Running torque is the force required to rotate one ring at a known speed while keeping the other ring stationary. The main contributors to bearing torque are seal and lubrication type. For applications in which low starting and/or running torque is required, an Applications Engineer should be contacted for bearing specification recommendations.

Static (Cor) & Dynamic (Cr) Loads

In evaluating the static load conditions, any forces exerted during assembly and test must be considered along with vibration and impact loads sustained during handling, test, shipment and assembly. Dynamic loading includes built-in pre-load, weight of supported members, and the effect of any accelerations due to vibration or motion changes. The static and dynamic radial load ratings are shown for each chassis size on the product listing pages. Descriptions of these calculated load ratings can be found in the Engineering Information Section.

Optimum Lubricant

Selection of the lubricant is extremely important. Many lubricants are available for varying conditions and requirements. An NMB Sales or Applications Engineer can help you select the lubricant best suited to your application.

Unless torque is a problem, the selection of a grease is much preferred in prelubricating bearings since it is less susceptible to migration and leakage. Grease can multiply the inherent bearing torque by a factor of 1.2 to 5.0, depending on the type and quantity of grease in the bearing. A discussion of lubrication and a partial listing of our most common greases can be found in the Engineering Information Section.

Ball Bearing Components

To assist in selecting the bearing with the proper components for a particular design or use, an exploded view of a standard ball bearing with component callouts is shown, below right. To further illustrate the relative positioning of these components in the ball bearing assembly, a cross section, right, is also shown. A detailed discussion of the various components, materials and dimensional tolerances can be found in Section 4, Engineering Information.

Cross section view of ball bearing

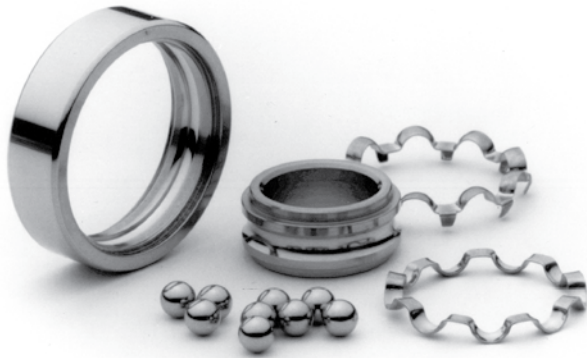
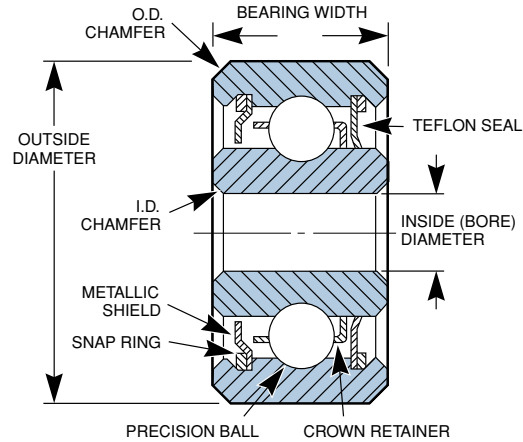

Exploded view of ball bearing

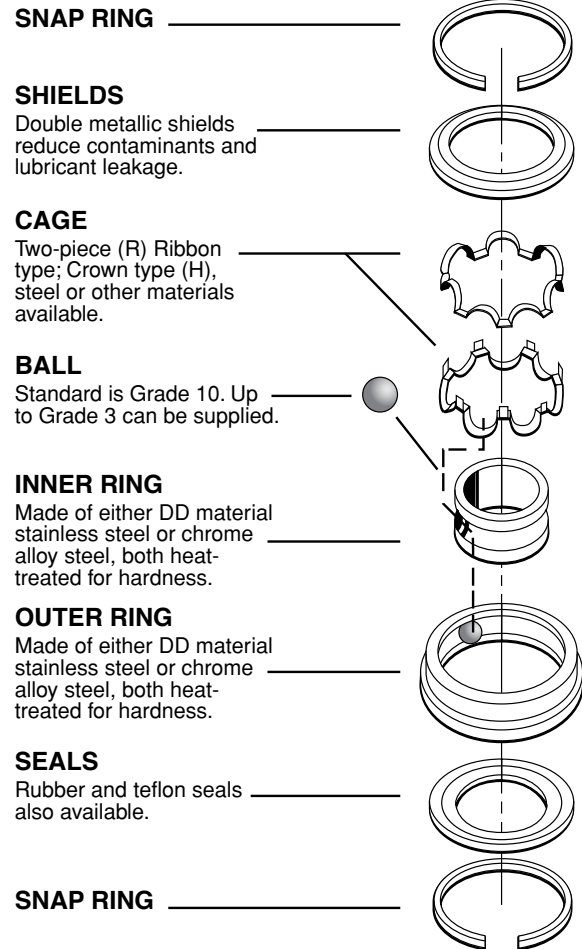

Basic Dimension Data

The dimensions and their associated symbols used throughout the catalog are described and defined below. The listing of these dimensions establish bearing size and other bearing parameters so designers may choose the ball bearing most suited to their requirement.

The Reference Codes shown in the figures below and used throughout this catalog are defined as follows:

- d** ——— Inside Diameter or Bore
- D** ——— Outside Diameter – O.D.
- B** ——— Inner Ring Width
- C** ——— Outer Ring Width
- D_f** ——— Flange Outside Diameter
- B_f** ——— Flange Width or Thickness
- L_i** ——— Inner Ring Reference Diameter
- L_o** ——— Outer Ring Reference Diameter
- r** ——— Maximum Shaft or Housing Fillet Radius that bearing corners will clear
- Z** ——— Number of balls
- D_w** ——— Nominal diameter of balls

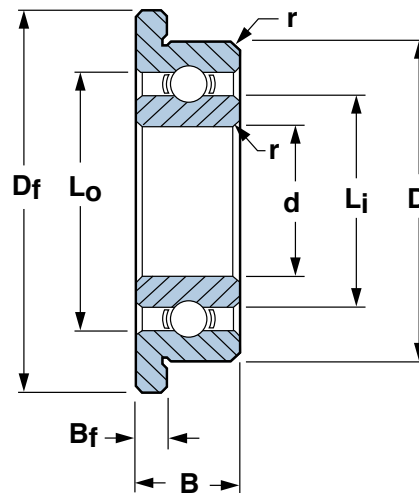
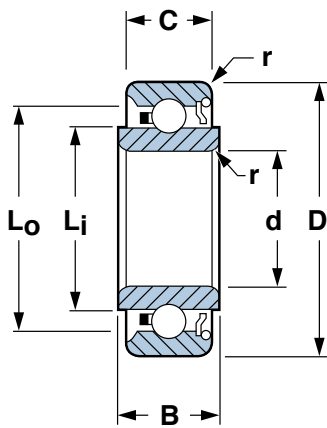

Part Numbering System

Example

DD RIF-418 ZZEE H A7 P25 LY75
R-1350 ZZ R A5 P25 L01
RI-5532 R A7 P25 L01

GROUP 1	GROUP 2	GROUP 3	GROUP 4	GROUP 5	GROUP 6
MATERIAL	TYPE	BASIC SIZE	FEATURES	ANDERON METER TEST AND SPECIAL DESIGNS	CAGE
DD	RIF-	418	ZZEE		H
	R-	1350	ZZ		R
	RI-	5532			R
<p>DD™ = NMB developed stainless steel material which falls within the 400 series Martensitic Stainless Steel grouping.</p> <p>NO CODE = Chrome alloy steel (52100 or equivalent)</p>	<p>RI, R, L = Radial ball bearings</p> <p>RIF, RF, LF = Flanged radial ball bearings</p> <p>RI, RIF = Inch Series</p> <p>R, L, RF, LF = Metric Series (exceptions: R-2, R-3, R-4 = inch series)</p>	<p>INCH SERIES</p> <p>First one or two digits indicates O.D. in 16ths of an inch. The following two or three digits indicate the bore size in a fraction of an inch, the first digit being the numerator and the second or the second and third digits being the denominator.</p> <p>METRIC SERIES</p> <p>First two digits indicate O.D. in mm. Second two digits indicate I.D. in mm.</p> <p>X- ___ =</p> <p>Indicates special internal design assigned in numerical sequence i.e., X1, X2, etc.</p>	<p>ENCLOSURES</p> <p>Z = Single metallic shield-removable</p> <p>ZZ = Double metallic shield-removable</p> <p>D = Single rubber seal-contact</p> <p>DD = Double rubber seal-contact</p> <p>H = Single metallic shield non-removable</p> <p>HH = Double metallic shield non-removable</p> <p>K = Single metallic shield non-removable</p> <p>KK = Double metallic shield non-removable</p> <p>L = Single glass reinforced PTFE seal-contact</p> <p>LL = Double glass reinforced PTFE seal-contact</p> <p>S = Single rubber seal non-contact</p> <p>SS = Double rubber seal non-contact</p> <p>LZ = Glass reinforced PTFE seal and shield with seal on flange side</p> <p>ZL = Shield and glass reinforced PTFE seal with shield on flange side</p> <p>DZ = Rubber seal and shield</p> <p>EXTENDED INNER RING</p> <p>EE = Both sides</p>	<p>ANDERON METER TEST</p> <p>MT = Motor quality</p> <p>GT = Extremely quiet-H.D.D. spindle motor only</p> <p>No Code = Non-critical application</p> <p>SPECIAL DESIGN</p> <p>SD = Special design bearing</p> <p>Note</p> <p>Noise codes are the dynamic evaluation of the bearing's performance. By listening to the internal sounds of a bearing in motion (Anderon based testing), NMB can scientifically categorize its bearings into noise levels. By evaluating application needs, the product designer can now coordinate these noise codes and AVEC classes to achieve the most cost effective combination of noise and performance.</p>	<p>H = Metallic Crown</p> <p>R = Metallic Ribbon</p> <p>MN = Glass fiber reinforced molded nylon</p>

Basic Information

Part Numbering System

GROUP 7	GROUP 8	GROUP 9	GROUP 10
ABEC TOLERANCE	RADIAL PLAY	LUBRICANT	LUBE QUANTITY
A7	P25	LY72	L
A5	P25	LOI	
A7	P25	LOI	

A1 = ABEC 1
A3 = ABEC 3
A5 = ABEC 5
A7 = ABEC 7

Note
 A1 miniature and instrument bearings of both the metric and inch configurations meet the tolerances of ABMA Standard 20 for ABEC 1 metric series bearings.

P = Followed by two or three numbers indicate the radial play limits in ten thousandths of an inch. Example: P25 indicates radial play of .0002" to .0005"

Note
 Radial play is the internal radial looseness between the balls and the races. Radial play is necessary to accommodate differential thermal expansions, the effects of interference fits, and to control axial play.

Lubricant letter codes are followed by a number to indicate specific type.
LO = Oil
LG = Greases
LY = Other Oils and Greases
LD = Dry-No Lubrication (DD Material Only)

X = 5-10%
L = 10-15%
T = 15-20%
No Code = 25-35%
H = 40-50%
J = 50-60%
F = 100%
 Percentage of void volume

IMPORTANT NOTE:

The NMB numbering system identifies ball bearing size and design. This system is not a guide to create a customized ball bearing. Please use the numbering system to decipher the basic bearing numbers listed in this catalog, or to define a number given to you by a representative of NMB. Bearing numbering systems which are different are explained in the pertinent sections of this catalog. Please consult a member of our Sales or Engineering staff to help you design a new bearing or to interchange another manufacturer's part number.

Part Numbering System

NMB Metric 600/6000

Example

608 DD NR M3 SM A3 LY121 H

GROUP 1	GROUP 2	GROUP 3	GROUP 4	GROUP 5	GROUP 6
BASIC CHASSIS NUMBER	CAGE	ENCLOSURE	EXTERNAL RETAINING RING	RADIAL PLAY	NOISE RATING
608	MN	DD	NR	M3	SM
<p>See page 3.6 for listings of Metric 600/6000 Series</p>	<p>MN = Glass fiber reinforced molded plastic retainer No Code = Ribbon retainer</p>	<p>Z = Single press type metal shield, non-removable D = Single contact rubber seal S = Single non-contact rubber seal Labyrinth design seal available on some sizes SSD21 = Labyrinth non-contact rubber seal DSD21 = Labyrinth contact rubber seal DSD64 = Double lip contact rubber seal No Code = Open bearing (Limited Availability) NOTE: Any combination of two enclosure types is available, i.e., ZZ, DD, SS, ZD, DS, ZS.</p>	<p>N = Groove only NR = Groove with retaining ring installed No Code = No groove or retaining ring NOTE: An external retaining ring is used where a flange effect is needed, but where the extra cost and stability of an integral flange are not required. Consult NMB for dimensions.</p>	<p>M2 = 0.003 - 0.008 mm M3 = 0.005 - 0.010 mm M4 = 0.008 - 0.013 mm M5 = 0.013 - 0.020 mm NOTE: Radial play is the internal radial looseness between the balls and the races. Radial play is necessary to accommodate differential thermal expansions, the effects of interference fits and to control axial play.</p>	<p>SM = Vibration critical applications MT = Extremely noise sensitive applications NOTE: Noise codes are the dynamic evaluation of the bearing's performance. By listening to the internal sounds of a bearing in motion (Anderson based testing), NMB can scientifically categorize its bearings into noise levels. By evaluating application needs, the product designer can now coordinate these noise codes and ABEC classes to achieve the most cost effective combination of noise and performance.</p>

Basic Information

Part Numbering System

NMB Metric 600/6000

GROUP 7	GROUP 8	GROUP 9
ABEC CLASSES	LUBRICANT	LUBE QUANTITY
A3	LY121	H
<p>A1 = ABEC 1 A3 = ABEC 3 A5 = ABEC 5 A7 = ABEC 7</p> <p>NOTE: ABEC classes do not specify noise limits. In certain applications, if runouts and fits are non-critical, it may be possible to achieve the dynamic effects of higher ABEC class bearings by specifying an ABEC 1 bearing with a SM or MT noise code. This could lead to a significant cost savings.</p>	<p>L121 = Multemp SRL, Ester/Lithium Soap Grease LY500 = Fluorinated Oil/PTFE Grease LY551 = Synthetic Hydrocarbon (PAO) Urea Grease</p>	<p>X = 5-10% L = 10-15% T = 15-20% No Code = 25-35% H = 40-50% J = 50-60% F = 100%</p> <p>Percentage of void volume</p>



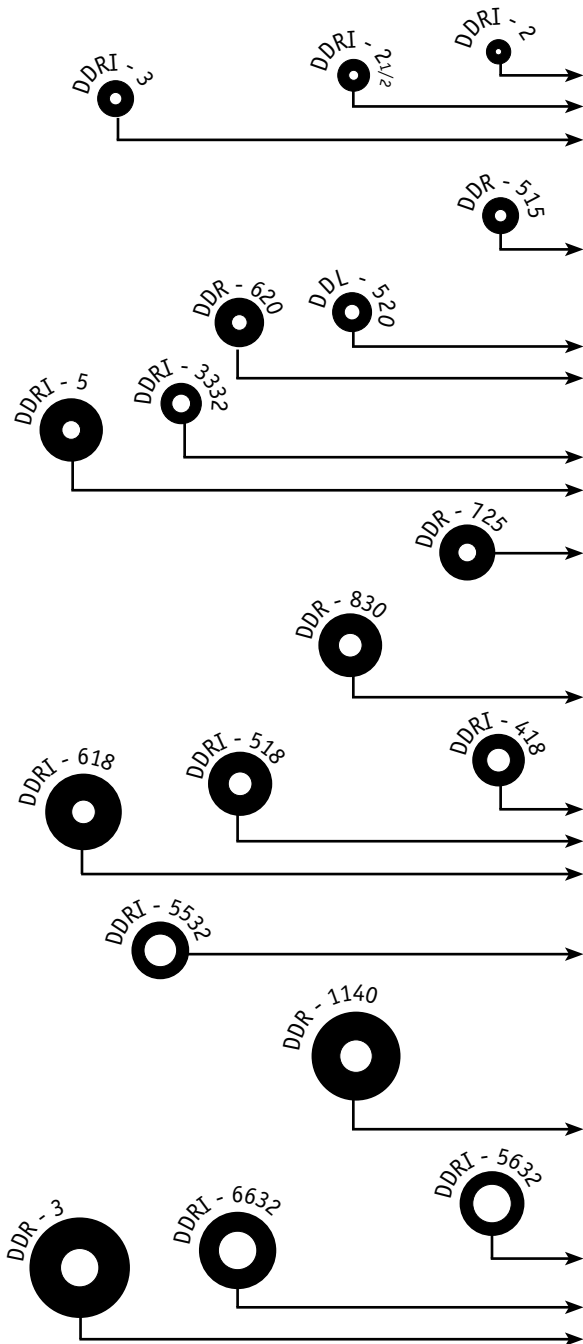

Index

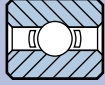
(Actual Size)

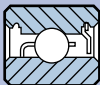
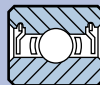

BORE d	O.D. D	*BASIC NUMBER	NO. Z	SIZE D _w (MM)	BEARING WIDTH	
					B OPEN 	SEE PAGE
.0394	.1181	DDL-310	7	.5000	.0394	3.2
.0394	.1575	DDR-410	6	.7938	.0630	3.4
.0400	.1250	DDRI-2	6	.6350	.0469	2.2
.0469	.1562	DDRI-2 1/2	6	.7938	.0625	2.2
.0550	.1875	DDRI-3	5	1.1906	.0781	2.2
.0472	.1575	DDR-412	6	.7938	.0709	3.4
.0591	.1575	DDL-415	7	.6000	.0472	3.2
.0591	.1969	DDR-515	7	.7938	.0787	3.4
.0591	.2362	DDR-615	6	1.1906	.0984	3.4
.0781	.2500	DDRI-4	6	1.1906	.0937	2.2
.0787	.1969	DDL-520	7	.7938	.0591	3.2
.0787	.2362	DDR-620	7	1.0000	.0906	3.4
.0787	.2756	DDR-720	7	1.1906	.1102	3.4
.0937	.1875	DDRI-3332	7	.7938	.0625	2.2
.0937	.3125	DDRI-5	6	1.5875	.1094	2.2
.0984	.2362	DDL-625	8	.7938	.0709	3.2
.0984	.2756	DDR-725	7	1.1906	.0984	3.4
.0984	.3150	DDR-825	6	1.5875	.1102	3.4
.1181	.2362	DDL-630	8	.7938	.0787	3.2
.1181	.2756	DDL-730	7	1.1906	.0787	3.2
.1181	.3150	DDR-830	6	1.5875	.1181	3.4
.1181	.3543	DDR-930	7	1.5875	.1181	3.4
.1181	.3937	DDR-1030	7	1.5875	.1575	3.4
.1250	.2500	DDRI-418	7	1.0000	.0937	2.2
.1250	.3125	DDRI-518	6	1.5875	.1094	2.2
.1250	.3750	DDRI-618	6	1.5875	.1094	2.2
.1250	.3750	DDR-2	7	1.5875	.1562	2.2
.1562	.3125	DDRI-5532	7	1.1906	.1094	2.2
.1575	.2756	DDL-740	11	.7938	.0787	3.2
.1575	.3150	DDL-840	7	1.1906	.0787	3.2
.1575	.3543	DDL-940	7	1.5875	.0984	3.2
.1575	.3937	DDL-1040	8	1.5875	.1181	3.2
.1575	.4331	DDR-1140	8	1.5875	.1575	3.4
.1575	.4724	DDR-1240	7	2.0000	.1575	3.4
.1575	.5118	DDR-1340	7	2.3813	.1969	3.4
.1575	.6299	DDR-1640	7	2.7781	.1969	3.4
.1875	.3125	DDRI-5632	7	1.1906	.1094	2.2
.1875	.3750	DDRI-6632	8	1.5875	.1250	2.2
.1875	.5000	DDR-3	7	2.3813	.1562	2.2
.1969	.3150	DDL-850	13	.7938	.0787	3.2
.1969	.3543	DDL-950	10	1.1906	.0984	3.2
.1969	.3937	DDL-1050	8	1.5875	.1181	3.2

* "DD" is a trademark of NMB

BEARING WIDTH		BEARING WIDTH		FLANGED *BASIC NUMBER	NO. Z	FLANGED WIDTH			FLANGED WIDTH		FLANGED WIDTH		STD. REFER TO
B 1SHIELD 	GO TO PG.	B 2 SHIELDS 	GO TO PG.			SIZE D _W (MM)	B OPEN 	GO TO PG.	B 1 SHIELD 	GO TO PG.	B 2 SHIELDS 	GO TO PG.	
—	—	—	—	DDLF-310	7	.5000	.0394	3.2	—	—	—	—	—
.0787	3.5	.0787	3.5	—	—	—	—	—	—	—	—	—	—
—	—	—	—	DDRIF-2	6	.6350	.0469	2.4	—	—	—	—	R0-9
.0937	2.3	.0937	2.3	DDRIF-2 1/2	6	.7938	.0625	2.4	.0937	2.5	.0937	2.5	R0
.0937	2.3	.1094	2.3	DDRIF-3	5	1.1906	.0781	2.4	.1094	2.5	.1094	2.5	R1
—	—	—	—	—	—	—	—	—	—	—	—	—	—
—	—	.0787	3.3	DDLF-415	7	.6350	.0472	3.2	—	—	—	—	—
.1024	3.5	.1024	3.5	DDRF-515	7	.7938	.0787	3.4	.1024	3.5	.1024	3.5	—
.1181	3.5	.1181	3.5	DDRF-615	6	1.1906	.0984	3.4	.1181	3.5	.1181	3.5	—
.1094	2.5	.1406	2.5	DDRIF-4	6	1.1906	.0937	2.4	.1406	2.5	.1406	2.5	R1-4
—	—	.0906	3.2	DDLF-520	7	.7938	.0591	3.2	—	—	.0906	3.3	—
.1181	3.5	.1181	3.5	DDRF-620	6	1.1906	.0906	3.4	.1181	3.5	.1181	3.5	—
.1378	3.5	.1378	3.5	DDRF-720	7	1.1906	.1102	3.4	.1378	3.5	.1378	3.5	—
.0937	2.3	.0937	2.3	DDRIF-3332	7	.7938	.0625	2.4	.0937	2.5	.0937	2.5	R133
.1094	2.3	.1406	2.3	DDRIF-5	6	1.5875	.1094	2.4	.1406	2.5	.1406	2.5	R1-5
—	—	.1024	3.2	DDLF-625	8	.7938	.0709	3.2	—	—	.1024	3.3	—
.1378	3.5	.1378	3.5	DDRF-725	7	1.1906	.0984	3.4	.1378	3.5	.1378	3.5	—
.1575	3.5	.1575	3.5	DDRF-825	6	1.5875	.1102	3.4	.1575	3.5	.1575	3.5	—
—	—	.0984	3.2	DDLF-630	8	.7938	.0787	3.2	—	—	.0984	3.3	—
—	—	.1181	3.2	DDLF-730	7	1.1906	.0787	3.2	—	—	.1181	3.3	—
.1575	3.5	.1575	3.5	DDRF-830	6	1.5875	.1181	3.4	.1575	3.5	.1575	3.5	—
.1969	3.5	.1969	3.5	DDRF-930	7	1.5875	.1181	3.4	.1969	3.5	.1969	3.5	—
.1575	3.5	.1575	3.5	DDRF-1030	7	1.5875	.1575	3.4	.1575	3.5	.1575	3.5	—
.0937	2.3	.1094	2.3	DDRIF-418	7	1.0000	.0937	2.4	.1094	2.5	.1094	2.5	R144
.1094	2.3	.1406	2.3	DDRIF-518	6	1.5875	.1094	2.4	.1406	2.5	.1406	2.5	R2-5
.1094	2.3	.1406	2.3	DDRIF-618	6	1.5875	.1094	2.4	.1406	2.5	.1406	2.5	R2-6
.1562	2.3	.1562	2.3	DDRF-2	7	1.5875	.1562	2.4	.1562	2.5	.1562	2.5	R-2
.1094	2.3	.1250	2.3	DDRIF-5532	7	1.1906	.1094	2.4	.1250	2.5	.1250	2.5	R155
—	—	.0984	3.2	DDLF-740	11	.7938	.0787	3.2	—	—	.0984	3.3	—
—	—	.1181	3.2	DDLF-840	7	1.1906	.0787	3.2	—	—	.1181	3.3	—
—	—	.1575	3.2	DDLF-940	7	1.5875	.0984	3.2	—	—	.1575	3.3	—
—	—	.1575	3.2	DDLF-1040	8	1.5875	.1181	3.2	—	—	.1575	3.3	—
.1575	3.5	.1575	3.5	DDRF-1140	8	1.5875	.1575	3.4	.1575	3.5	.1575	3.5	—
.1575	3.5	.1575	3.5	DDRF-1240	7	2.0000	.1575	3.4	.1575	3.5	.1575	3.5	—
.1969	3.5	.1969	3.5	DDRF-1340	7	2.3813	.1969	3.4	.1969	3.5	.1969	3.5	—
—	3.5	.1969	3.5	DDRF-1640	7	2.7781	.1969	3.4	.1969	3.5	.1969	3.5	—
.1094	2.3	.1250	2.3	DDRIF-5632	7	1.1906	.1094	2.4	.1250	3.5	.1250	2.5	R156
.1250	2.3	.1250	2.3	DDRIF-6632	8	1.5875	.1250	2.4	.1250	2.5	.1250	2.5	R166
.1960	2.3	.1960	2.3	DDRF-3	7	2.3813	.1562	2.4	.1960	2.5	.1960	2.5	R-3
—	—	.0984	3.2	DDLF-850	13	.7938	.0787	3.3	—	—	.0984	3.3	—
—	—	.1181	3.2	DDLF-950	10	1.1906	.0984	3.3	—	—	.1181	3.3	—
—	—	.1575	3.2	DDLF-1050	8	1.5875	.1181	3.3	—	—	.1575	3.3	—

* "DD" is a trademark of NMB



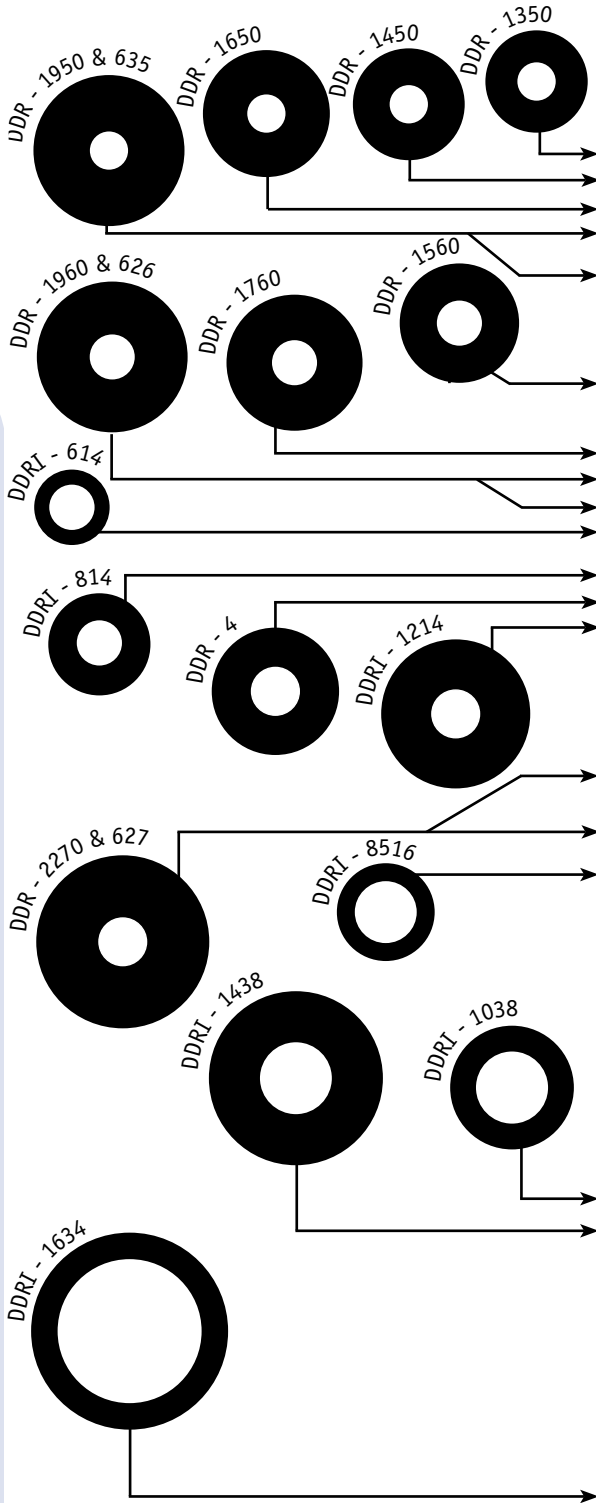

Index

(Actual Size)

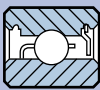
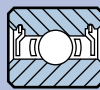

BORE d	O.D. D	*BASIC NUMBER	NO. Z	SIZE D _w (MM)	BEARING WIDTH	
					B OPEN 	SEE PAGE
.1969	.4331	DDL-1150	8	1.5875	.1181	3.2
.1969	.5118	DDR-1350	8	2.0000	.1575	3.4
.1969	.5512	DDR-1450	7	2.3813	.1969	3.4
.1969	.6299	DDR-1650	7	2.7781	.1969	3.4
.1969	.7480	635	7	3.5000	.2362	3.6
.1969	.7480	DDR-1950	6	3.9688	.2362	3.4
.2362	.3937	DDL-1060	9	1.1906	.0984	3.2
.2362	.4724	DDL-1260	10	1.5875	.1181	3.2
.2362	.5118	DDL-1360	8	2.0000	.1378	3.2
.2362	.5906	DDR-1560	7	2.7781	.1969	3.4
.2362	.6299	DDR-1660	7	2.7781	.1969	3.4
.2362	.6693	DDR-1760	6	3.5000	.2362	3.4
.2362	.7480	626	7	3.5000	.2362	3.6
.2362	.7480	DDR-1960	6	3.9688	.2362	3.4
.2500	.3750	DDRI-614	13	1.0000	.1250	2.2
.2500	.5000	DDRI-814	10	1.5875	.1250	2.2
.2500	.6250	DDR-4	8	2.3813	.1960	2.2
.2500	.7500	DDRI-1214	6	3.5719	.2188	2.2
.2756	.4331	DDL-1170	9	1.1906	.0984	3.2
.2756	.5118	DDL-1370	11	1.5875	.1181	3.2
.2756	.5512	DDL-1470	9	2.0000	.1378	3.2
.2756	.7480	607	7	3.5000	.2362	3.6
.2756	.8661	627	7	3.9688	.2756	3.6
.2756	.7480	DDR-1970	7	3.1750	.2362	3.4
.2756	.8661	DDR-2270	7	3.9688	.2756	3.4
.3125	.5000	DDRI-8516	11	1.5875	.1562	2.2
.3150	.4724	DDL-1280	11	1.1906	.0984	3.2
.3150	.5512	DDL-1480	10	1.5875	.1378	3.2
.3150	.6299	DDL-1680	9	2.3813	.1575	3.2
.3150	.7480	DDR-1980	8	3.1750	.2362	3.4
.3150	.8861	608	7	3.9688	.2756	3.6
.3150	.8661	DDR-2280	7	3.9688	.2756	3.4
.3543	.6693	DDL-1790	10	2.3813	.1575	3.2
.3543	.7874	DDL-2090	9	2.7781	.2362	3.2
.3543	.9449	609	7	3.9688	.2756	3.6
.3543	1.0236	629	7	4.7625	.3150	3.6
.3750	.6250	DDRI-1038	12	1.5875	.1562	2.2
.3750	.8750	DDRI-1438	7	3.9688	.2188	2.2
.3937	.7480	DDL-1910	9	2.7781	.1969	3.2
.3937	.8661	DDR-2210	9	3.1750	.2362	3.4
.3937	1.0236	6000	7	4.7625	.3150	3.6
.4724	.8268	DDL-2112	12	2.3813	.1969	3.2
.4724	.9449	DDR-2412	8	3.5719	.2362	3.4
.5000	.7500	DDRI-1212	16	1.5875	.1562	2.2
.5000	1.1250	DDRI-1812	8	4.7625	.2500	2.2
.6250	.8750	DDRI-1458	18	1.5875	.1562	2.2
.7500	1.0000	DDRI-1634	22	1.5875	.1562	2.2

* "DD" is a trademark of NMB

BEARING WIDTH		BEARING WIDTH		FLANGED *BASIC NUMBER	NO. Z	FLANGED WIDTH		FLANGED WIDTH		FLANGED WIDTH		STD. REFER TO	
B 1 SHIELD 	GO TO PG.	B 2 SHIELDS 	GO TO PG.			SIZE D _W (MM)	B OPEN 	GO TO PG.	B 1 SHIELD 	GO TO PG.	B 2 SHIELDS 		GO TO PG.
—	—	.1969	3.3	DDLFL-1150	8	1.5875	.1181	3.2	—	—	.1969	3.3	—
.1575	3.5	.1575	3.5	DDRF-1350	8	2.0000	.1575	3.4	.1575	3.5	.1575	3.5	—
.1969	3.5	.1969	3.5	DDRF-1450	7	2.3813	.1969	3.4	.1969	3.5	.1969	3.5	—
.1969	3.5	.1969	3.5	DDRF-1650	7	2.7781	.1969	3.4	.1969	3.5	.1969	3.5	—
.2362	3.6	.2362	3.6	—	—	—	—	—	—	—	—	—	—
.2362	3.5	.2362	3.5	DDRF-1950	6	3.9688	.2362	3.4	.2362	3.5	.2362	3.5	35
—	—	.1181	3.3	DDLFL-1060	9	1.1906	.0984	3.2	—	—	.1181	3.3	—
—	—	.1575	3.3	DDLFL-1260	10	1.5875	.1181	3.2	—	—	.1575	3.3	—
—	—	.1969	3.3	DDLFL-1360	8	2.0000	.1378	3.2	—	—	.1969	3.3	—
.1969	3.5	.1969	3.5	DDRF-1560	7	2.7781	.1969	3.4	.1969	3.5	.1969	3.5	—
.1969	3.5	.1969	3.5	—	—	—	—	—	—	—	—	—	—
.2362	3.5	.2362	3.5	DDRF-1760	6	3.5000	.2362	3.4	.2362	3.5	.2362	3.5	—
.2362	3.6	.2362	3.6	—	—	—	—	—	—	—	—	—	—
.2362	3.5	.2362	3.5	DDRF-1960	6	3.9688	.2362	3.4	.2362	3.5	.2362	3.5	36
.1250	2.3	.1250	2.3	DDRIF-614	13	1.0000	.1250	2.4	.1250	2.5	.1250	2.5	R168
.1250	2.3	.1875	2.3	DDRIF-814	10	1.5875	.1250	2.4	.1875	2.5	.1875	2.5	R188
.1960	2.3	.1960	2.3	DDRF-4	8	2.3813	.1960	2.4	.1960	2.5	.1960	2.5	R-4
.2812	2.3	—	—	—	—	—	—	—	—	—	—	—	—
—	—	.1181	3.3	DDLFL-1170	9	1.1906	.0984	3.2	—	—	.1181	3.3	—
—	—	.1575	3.3	DDLFL-1370	11	1.5875	.1181	3.2	—	—	.1575	3.3	—
—	—	.1969	3.3	DDLFL-1470	9	2.0000	.1378	3.2	—	—	.1969	3.3	—
.2362	3.6	.2362	3.6	—	—	—	—	—	—	—	—	—	—
.2756	3.6	.2756	3.6	—	—	—	—	—	—	—	—	—	—
.2362	3.5	—	—	—	—	—	—	—	—	—	—	—	—
.2756	3.5	.2756	3.5	DDRF-2270	7	3.9688	.2756	3.4	.2756	3.5	.2756	3.5	37
.1562	2.3	.1562	2.3	DDRIF-8516	11	1.5875	.1562	2.4	.1562	2.5	.1562	2.5	R1810
—	—	.1378	3.3	DDLFL-1280	11	1.1906	.0984	3.2	—	—	.1575	3.3	—
—	—	.1575	3.3	DDLFL-1480	10	1.5875	.1378	3.2	—	—	.1575	3.3	—
—	—	.1969	3.3	DDLFL-1680	9	2.3813	.1575	3.2	—	—	.1969	3.3	—
.2362	3.4	.2362	3.5	DDRF-1980	7	3.1750	—	—	—	—	—	—	—
.2756	3.6	.2756	3.6	—	—	—	—	—	—	—	—	—	—
.2756	3.4	.2756	3.5	DDRF-2280	7	3.9688	.2756	3.4	.2756	3.5	.2756	3.5	38
—	—	.1969	3.3	DDLFL-1790	10	2.3813	.1575	3.2	—	—	.1969	3.3	—
—	—	.2362	3.3	—	—	—	—	—	—	—	—	—	—
.2756	3.6	.2756	3.6	—	—	—	—	—	—	—	—	—	—
.3150	3.6	.3150	3.6	—	—	—	—	—	—	—	—	—	—
.1562	2.3	.1562	2.3	—	—	—	—	—	—	—	—	—	R620
.2812	2.3	.2812	2.3	DDRIF-1438	7	3.9688	.2812	2.4	.2812	2.5	.2812	2.5	R-6
—	—	.2756	3.3	—	—	—	—	—	—	—	—	—	—
.2362	3.5	.2362	3.5	DDRF-2210	9	3.1750	—	—	.2362	3.5	.2362	3.5	—
.3150	3.6	.3150	3.6	—	—	—	—	—	—	—	—	—	—
—	—	.1969	3.3	—	—	—	—	—	—	—	—	—	—
.2362	3.5	.2362	3.5	—	—	—	—	—	—	—	—	—	—
.1562	2.3	.1562	2.3	—	—	—	—	—	—	—	—	—	R824
.3125	2.3	.3125	2.3	—	—	—	—	—	—	—	—	—	—
.1562	2.3	.1562	2.3	—	—	—	—	—	—	—	—	—	RI028
.1562	2.3	.1562	2.3	—	—	—	—	—	—	—	—	—	RI232

* "DD" is a trademark of NMB

Ultra Precision Machining Technology

The precision of a ball bearing is determined by several factors, including the raceway roundness of the inner and outer rings, the sphericity of the balls and the quality of the balls and the raw materials used in each of the bearing's components. Improving precision demands uncompromising strictness on all counts. Building on expertise amassed over 60 years, NMB has developed high-precision machining equipment, sophisticated maintenance technologies and efficient plant-line layout, enabling it to produce all parts of its bearings in-house and to aim constantly for higher levels of precision.



Inch Series Bearings

Standard inch series radial bearings carry moderate radial and thrust loads at low operating torque and provide high performance within small envelope designs.

All miniature and instrument bearings of both the metric and inch configurations meet the tolerances of ABMA Standard 20 for ABEC 1 metric series bearings.

Stainless steel or chrome steel bearings are available with crown or ribbon type metallic cages. Open or shielded bearings may be flanged or unflanged. Various types of seals may be specified depending upon the anticipated environment to which the bearings will be exposed. (See Engineering Section for seal information)

Radial open bearings.....	2.2
Bore sizes: .0400"-.7500"	
Radial shielded bearings.....	2.3
Bore sizes: .0469"-.7500"	
Radial flanged open bearings.....	2.4
Bore sizes: .0400"-.3750"	
Radial flanged shielded bearings.....	2.5
Bore sizes: .0469"-.3750"	
Extended inner ring radial open	2.6
bearings, flanged, unflanged	
Bore sizes: .0400"-.3125"	
Extended inner ring radial.....	2.7
shielded bearings, flanged, unflanged	
Bore sizes: .0469"-.3125"	
Consistently Superior Quality Worldwide	2.8

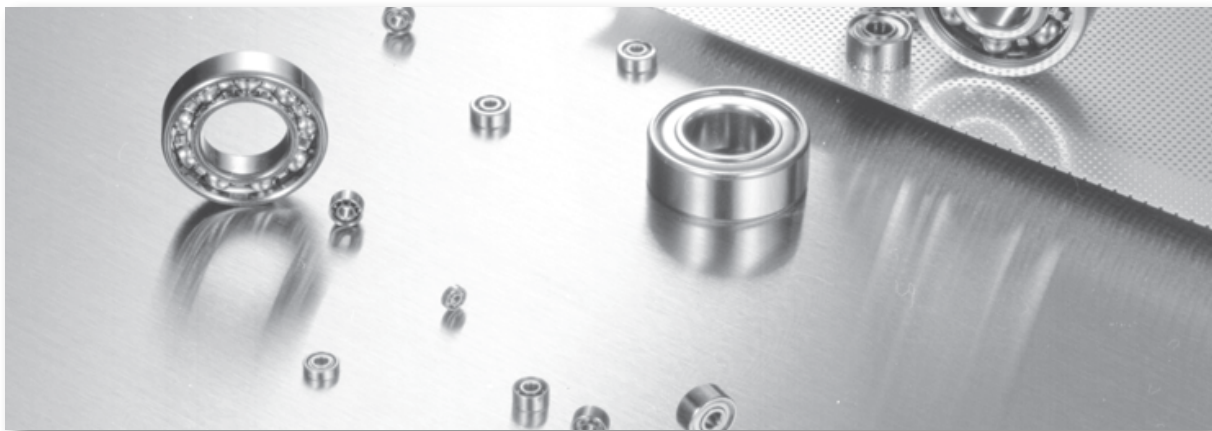

Radial Open Bearings

BORE d	O.D. D	WIDTH B	BASIC NUMBER*	REFERENCE DIAMETER		FILLET RADIUS r	LOAD RATINGS	
				L _i	L _o		N	
							DYN. C _r	STATIC C _{or}
.0400	.1250	.0469	DDRI-2	.065	.101	.003	106	28
.0469	.1562	.0625	DDRI-2 1/2	.081	.124	.003	158	44
.0550	.1875	.0781	DDRI-3	.093	.169	.003	264	71
.0781	.2500	.0937	DDRI-4	.122	.193	.003	330	99
.0937	.1875	.0625	DDRI-3332	.118	.163	.003	187	59
.0937	.3125	.1094	DDRI-5	.173	.271	.003	563	183
.1250	.2500	.0937	DDRI-418	.161	.217	.003	285	97
.1250	.3125	.1094	DDRI-518	.173	.271	.003	563	183
.1250	.3750	.1094	DDRI-618	.173	.271	.004	563	183
.1250	.3750	.1562	DDR-2	.200	.301	.012	641	226
.1562	.3125	.1094	DDRI-5532	.221	.279	.003	391	142
.1875	.3125	.1094	DDRI-5632	.221	.279	.003	391	142
.1875	.3750	.1250	DDRI-6632	.235	.343	.003	712	271
.1875	.5000	.1562	DDR-3	.276	.413	.012	1306	487
.2500	.3750	.1250	DDRI-614	.285	.340	.003	417	205
.2500	.5000	.1250	DDRI-814	.330	.432	.006	828	374
.2500	.6250	.1960	DDR-4	.323	.513	.012	1470	599
.2500	.7500	.2188	DDRI-1214	.386	.598	.012	2411	912
.3125	.5000	.1562	DDRI-8516	.362	.450	.006	878	419
.3750	.6250	.1562	DDRI-1038	.458	.543	.010	906	477
.3750	.8750	.2188	DDRI-1438	.520	.741	.012	3297	1368
.5000	.7500	.1562	DDRI-1212	.587	.672	.010	1051	662
.5000	1.1250	.2500	DDRI-1812	.676	.947	.012	5113	2387
.6250	.8750	.1562	DDRI-1458	.713	.798	.010	1092	742
.7500	1.0000	.1562	DDRI-1634	.837	.922	.010	1204	895

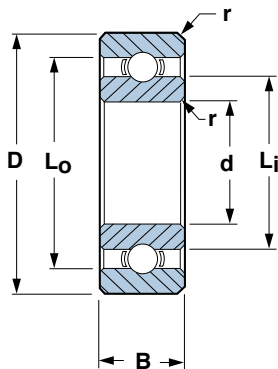

NOTES:

1. Inch to metric conversion - see Engineering Section.
2. Basic numbers shown above include code "DD" for NMB developed 400 series Martensitic stainless steel. If chrome steel is desired, delete "DD".
3. ABEC 1, 3, 5 and 7 tolerances apply.
4. r = Maximum shaft or housing fillet radius that bearing corners will clear.

* "DD" is a trademark of NMB.

Radial Shielded Bearings

BORE d	O.D. D	WIDTH B		*BASIC NUMBER	REFERENCE DIAMETER		FILLET RADIUS r	LOAD RATINGS	
		B			L _i	L _o		N	
		1 SHIELD	2 SHIELDS					DYN. C _r	STATIC C _{or}
.0469	.1562	.0937	.0937	DDRI-2 1/2	.081	.135	.003	158	44
.0550	.1875	.0937	.1094	DDRI-3	.093	.169	.003	264	71
.0781	.2500	.1094	.1406	DDRI-4	.122	.206	.003	330	99
.0937	.1875	.0937	.0937	DDRI-3332	.118	.169	.003	187	59
.0937	.3125	.1094	.1406	DDRI-5	.173	.283	.003	563	183
.1250	.2500	.0937	.1094	DDRI-418	.161	.230	.003	285	97
.1250	.3125	.1094	.1406	DDRI-518	.173	.283	.003	563	183
.1250	.3750	.1094	.1406	DDRI-618	.173	.283	.004	563	183
.1250	.3750	.1562	.1562	DDR-2	.200	.322	.012	641	226
.1562	.3125	.1094	.1250	DDRI-5532	.221	.288	.003	391	142
.1875	.3125	.1094	.1250	DDRI-5632	.221	.288	.003	391	142
.1875	.3750	.1250	.1250	DDRI-6632	.235	.343	.003	712	271
.1875	.5000	.1960	.1960	DDR-3	.276	.433	.012	1306	487
.2500	.3750	.1250	.1250	DDRI-614	.285	.350	.003	417	205
.2500	.5000	.1250	.1875	DDRI-814	.330	.455	.006	828	374
.2500	.6250	.1960	.1960	DDR-4	.323	.513	.012	1470	599
.2500	.7500	.2812	.2812	DDRI-1214	.340	.641	.012	2411	912
.3125	.5000	.1562	.1562	DDRI-8516	.362	.463	.005	878	419
.3750	.6250	.1562	.1562	DDRI-1038	.458	.543	.010	906	477
.3750	.8750	.2812	.2812	DDRI-1438	.474	.783	.012	3297	1368
.5000	.7500	.1562	.1562	DDRI-1212	.587	.689	.010	1051	662
.5000	1.1250	.3125	.3125	DDRI-1812	.630	.989	.016	5113	2387
.6250	.8750	.1562	.1562	DDRI-1458	.713	.815	.010	1092	742
.7500	1.0000	.1562	.1562	DDRI-1634	.837	.939	.010	1204	895

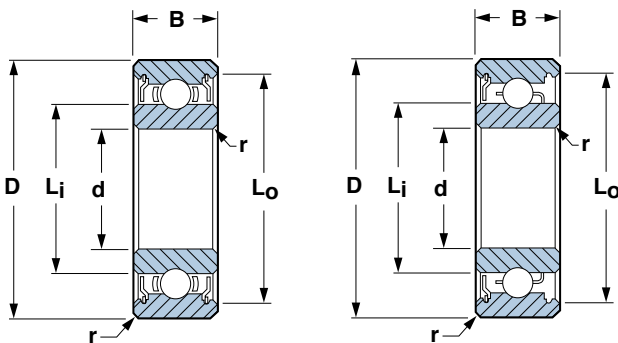

NOTES:

1. Inch to metric conversion - see Engineering Section.
2. Basic numbers shown above include code "DD" for NMB developed 400 series Martensitic stainless steel. If chrome steel is desired, delete "DD".
3. ABEC 1, 3, 5 and 7 tolerances apply.
4. r = Maximum shaft or housing fillet radius that bearing corners will clear.

* "DD" is a trademark of NMB.

Radial Flanged Open Bearings

BORE d	O.D. D	WIDTH B	*BASIC NUMBER	FLANGE DIA. D _f	FLANGE WIDTH B _f	REFERENCE DIAMETER		FILLET RADIUS r	LOAD RATINGS	
						L _i	L _o		N	
									DYN. C _r	STATIC C _{or}
.0400	.1250	.0469	DDRIF-2	.171	.013	.065	.101	.003	106	28
.0469	.1562	.0625	DDRIF-2 1/2	.203	.013	.081	.124	.003	158	44
.0550	.1875	.0781	DDRIF-3	.234	.023	.093	.169	.003	264	71
.0781	.2500	.0937	DDRIF-4	.296	.023	.122	.193	.003	330	99
.0937	.1875	.0625	DDRIF-3332	.234	.018	.118	.163	.003	187	59
.0937	.3125	.1094	DDRIF-5	.359	.023	.173	.270	.003	563	183
.1250	.2500	.0937	DDRIF-418	.296	.023	.161	.217	.003	285	97
.1250	.3125	.1094	DDRIF-518	.359	.023	.173	.271	.003	563	183
.1250	.3750	.1094	DDRIF-618	.422	.023	.173	.271	.004	563	183
.1250	.3750	.1562	DDRF-2	.440	.030	.200	.301	.012	641	226
.1562	.3125	.1094	DDRIF-5532	.359	.023	.221	.279	.003	391	142
.1875	.3125	.1094	DDRIF-5632	.359	.023	.221	.279	.003	391	142
.1875	.3750	.1250	DDRIF-6632	.422	.023	.235	.343	.003	712	271
.1875	.5000	.1562	DDRF-3	.565	.042	.276	.413	.012	1306	487
.2500	.3750	.1250	DDRIF-614	.422	.023	.285	.340	.003	417	205
.2500	.5000	.1250	DDRIF-814	.547	.023	.330	.432	.005	828	374
.2500	.6250	.1960	DDRF-4	.690	.042	.323	.513	.012	1470	599
.3125	.5000	.1562	DDRIF-8516	.547	.031	.362	.450	.005	878	419
.3750	.8750	.2812	DDRIF-1438	.969	.062	.520	.741	.012	3297	1368

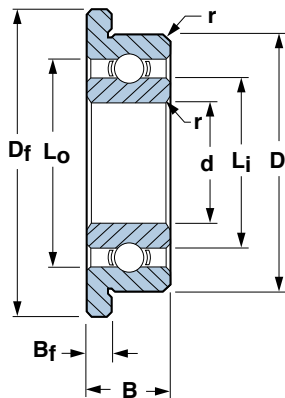

NOTES:

1. Inch to metric conversion - see Engineering Section.
2. Basic numbers shown above include code "DD" for NMB developed 400 series Martensitic stainless steel. If chrome steel is desired, delete "DD".
3. ABEC 1, 3, 5 and 7 tolerances apply.
4. r = Maximum shaft or housing fillet radius that bearing corners will clear.

* "DD" is a trademark of NMB.

Radial Flanged Shielded Bearings

BORE d	O.D. D	SHIELDED WIDTH B 1 OR 2 SHIELDS	*BASIC NUMBER	FLANGE DIA. D _f	FLANGE WIDTH B _f	REFERENCE DIAMETER		FILLET RADIUS r	LOAD RATINGS	
						L _i	L _o		N	
									DYN. C _r	STATIC C _{or}
.0469	.1562	.0937	DDRIF-2 1/2	.203	.031	.081	.135	.003	158	44
.0550	.1875	.1094	DDRIF-3	.234	.031	.093	.169	.003	264	71
.0781	.2500	.1406	DDRIF-4	.296	.031	.122	.206	.003	330	99
.0937	.1875	.0937	DDRIF-3332	.234	.031	.118	.168	.003	187	59
.0937	.3125	.1406	DDRIF-5	.359	.031	.173	.283	.003	563	183
.1250	.2500	.1094	DDRIF-418	.296	.031	.161	.230	.003	285	97
.1250	.3125	.1406	DDRIF-518	.359	.031	.173	.283	.003	563	183
.1250	.3750	.1406	DDRIF-618	.422	.031	.173	.283	.004	563	183
.1250	.3750	.1562	DDRF-2	.440	.030	.200	.322	.012	641	226
.1562	.3125	.1250	DDRIF-5532	.359	.036	.221	.288	.003	391	142
.1875	.3125	.1250	DDRIF-5632	.359	.036	.221	.288	.003	391	142
.1875	.3750	.1250	DDRIF-6632	.422	.031	.235	.343	.003	712	271
.1875	.5000	.1960	DDRF-3	.565	.042	.276	.435	.012	1306	487
.2500	.3750	.1250	DDRIF-614	.422	.036	.285	.348	.003	417	205
.2500	.5000	.1875	DDRIF-814	.547	.045	.330	.454	.005	828	374
.2500	.6250	.1960	DDRF-4	.690	.042	.323	.513	.012	1470	599
.3125	.5000	.1562	DDRIF-8516	.547	.031	.362	.463	.005	878	417
.3750	.8750	.2812	DDRIF-1438	.969	.062	.474	.783	.012	3297	1368

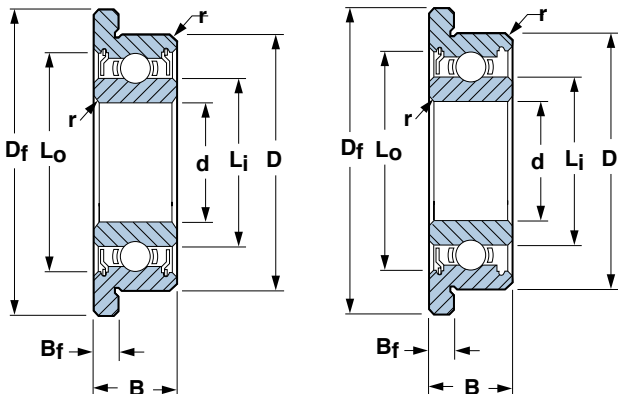

NOTES:

1. Inch to metric conversion - see Engineering Section.
 2. Basic numbers shown above include code "DD" for NMB developed 400 series Martensitic stainless steel. If chrome steel is desired, delete "DD".
 3. ABEC 1, 3, 5 and 7 tolerances apply.
 4. r = Maximum shaft or housing fillet radius that bearing corners will clear.
- * "DD" is a trademark of NMB.

Extended Inner Ring Radial Open Bearings Flanged and Unflanged

Inch Series Bearings

BORE d	O.D. D	WIDTH 1 OR 2 SHIELDS		*BASIC NUMBER†	FLANGE DIA. D _f	FLANGE WIDTH B _f	REFERENCE DIAMETER		FILLET RADIUS r	LOAD RATINGS	
		B	C				L _i	L _o		DYN. C _r	STATIC C _{or}
.0400	.1250	.0781	.0469	DDRI-2	.171	.013	.065	.101	.003	106	28
.0469	.1562	.0937	.0625	DDRI-2 1/2	.203	.013	.081	.124	.003	158	44
.0550	.1875	.1094	.0781	DDRI-3	.234	.023	.093	.169	.003	264	71
.0781	.2500	.1250	.0937	DDRI-4	.296	.023	.122	.193	.003	330	99
.0937	.1875	.0937	.0625	DDRI-3332	.234	.018	.118	.163	.003	187	59
.1250	.2500	.1250	.0937	DDRI-418	.296	.023	.161	.217	.003	285	97
.1250	.3125	.1406	.1094	DDRI-518	.359	.023	.173	.271	.003	563	183
.1250	.3750	.1406	.1094	DDRI-618	.422	.023	.173	.271	.005	563	183
.1250	.3750	.1875	.1562	DDR-2	.440	.030	.200	.301	.012	641	226
.1562	.3125	.1406	.1094	DDRI-5532	.359	.023	.221	.279	.003	391	142
.1875	.3125	.1406	.1094	DDRI-5632	.359	.023	.221	.279	.003	391	142
.1875	.3750	.1562	.1250	DDRI-6632	.422	.023	.235	.343	.003	712	271
.2500	.3750	.1562	.1250	DDRI-614	.422	.023	.285	.340	.003	417	205
.2500	.5000	.1562	.1250	DDRI-814	.547	.023	.330	.432	.005	828	374
.3125	.5000	.1875	.1562	DDRI-8516	.547	.031	.362	.450	.005	878	419

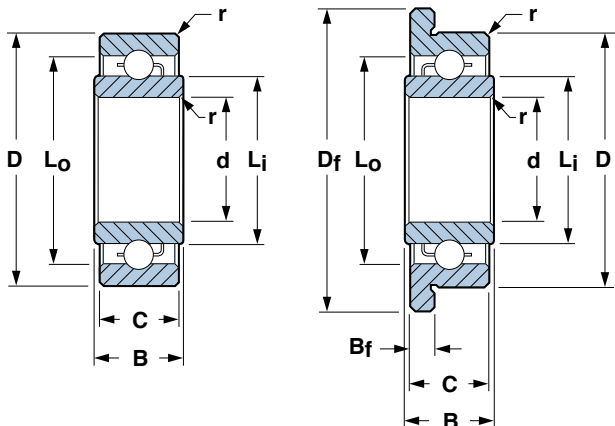

NOTES:

1. Inch to metric conversion - see Engineering Section.
2. Basic numbers shown above include code "DD" for NMB developed 400 series Martensitic stainless steel. If chrome steel is desired, delete "DD".
3. ABEC 1, 3, 5 and 7 tolerances apply.
4. r = Maximum shaft or housing fillet radius that bearing corners will clear.

† For flanged bearings substitute prefix DDRIF or DDRF

* "DD" is a trademark of NMB.

Extended Inner Ring Radial Shielded Bearings Flanged and Unflanged

BORE d	O.D. D	WIDTH 1 OR 2 SHIELDS		*BASIC NUMBER†	FLANGE DIA. D _f	FLANGE WIDTH B _f	REFERENCE DIAMETER		FILLET RADIUS r	LOAD RATINGS N	
		B	C				L _i	L _o		DYN. C _r	STATIC C _{or}
.0469	.1562	.1250	.0937	DDRI-2 1/2	.203	.031	.081	.135	.003	158	44
.0550	.1875	.1406	.1094	DDRI-3	.234	.031	.093	.169	.003	264	71
.0781	.2500	.1719	.1406	DDRI-4	.296	.031	.122	.206	.003	330	99
.0937	.1875	.1250	.0937	DDRI-3332	.234	.031	.118	.168	.003	187	59
.1250	.2500	.1406	.1094	DDRI-418	.296	.031	.161	.230	.003	285	97
.1250	.3125	.1719	.1406	DDRI-518	.359	.031	.173	.283	.003	563	183
.1250	.3750	.1719	.1406	DDRI-618	.422	.031	.173	.283	.004	563	183
.1250	.3750	.1875	.1562	DDR-2	.440	.030	.200	.322	.012	641	226
.1562	.3125	.1562	.1250	DDRI-5532	.359	.036	.221	.288	.003	391	142
.1875	.3125	.1562	.1250	DDRI-5632	.359	.036	.221	.288	.003	391	142
.1875	.3750	.1562	.1250	DDRI-6632	.422	.031	.235	.343	.003	712	271
.1875	.5000	.2272	.1960	DDR-3	.565	.042	.276	.435	.012	1306	487
.2500	.3750	.1562	.1250	DDRI-614	.422	.036	.285	.348	.003	417	205
.2500	.5000	.2188	.1875	DDRI-814	.547	.045	.330	.454	.005	828	374
.2500	.6250	.2260	.1960	DDR-4	.690	.042	.323	.513	.012	1470	599
.3125	.5000	.1875	.1562	DDRI-8516	.547	.031	.362	.463	.005	878	419

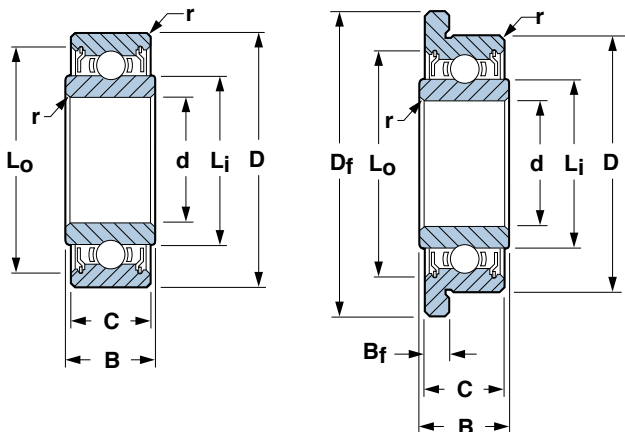

NOTES:

1. Inch to metric conversion - see Engineering Section.
2. Basic numbers shown above include code "DD" for NMB developed 400 series Martensitic stainless steel. If chrome steel is desired, delete "DD".
3. ABEC 1, 3, 5 and 7 tolerances apply.
4. r = Maximum shaft or housing fillet radius that bearing corners will clear.

† For flanged bearings substitute prefix DDRIF or DDRF

* "DD" is a trademark of NMB.

Consistently Superior Quality Worldwide

NMB currently has 10 bearing manufacturing facilities worldwide, all of which conduct vertically integrated production, which encompasses all processes from machining to final assembly and testing. These plants also utilize mass-production technologies and production lines developed at Minebea's parent plants in Japan. As a consequence, NMB is able to guarantee products of consistently superior quality, no matter where our products are manufactured.



Metric Series Bearings

Standard metric series radial bearings carry moderate radial and thrust loads at low operating torque and provide high performance within small envelope designs. Stainless steel or chrome steel bearings are available with crown or ribbon type metallic cages. Open or shielded bearings may be flanged or unflanged. Various types of seals may be specified depending upon the anticipated environment to which the bearings will be exposed. (See Engineering Section for seal information)

L SERIES

Radial open and flanged open bearings..... 3.2
Bore sizes: 1.0-12.0mm

Radial shielded and flanged shielded bearings..... 3.3
Bore sizes: 1.5-12.0mm

R SERIES

Radial open and flanged open bearings..... 3.4
Bore sizes: 1.0-12.0mm

Radial shielded and flanged shielded bearings..... 3.5
Bore sizes: 1.5-12.0mm

600/6000 SERIES

Radial open and shielded bearing..... 3.6
Bore sizes: 5-10mm



Radial Open and Flanged Open Bearings

Metric Series Bearings

BORE		O.D.		WIDTH		*BASIC NUMBER	FLANGE (MM)		FLANGED *BASIC NUMBER	REFERENCE DIAMETER (MM)		FILLET RADIUS r		LOAD RATINGS	
d	D	D	D	B	B		DIA.	WIDTH		L _i	L _o	MM	INCH	DYN.	STATIC
MM	INCH	MM	INCH	MM	INCH		D _f	B _f		MM	MM	MM	INCH	C _r	C _{or}
1.0	.0394	3.0	.1181	1.0	.0394	DDL-310	3.8	0.3	DDL-310	1.60	2.41	0.05	.002	80	23
1.5	.0591	4.0	.1575	1.2	.0472	DDL-415	5.0	0.4	DDL-415	2.26	3.25	0.05	.002	125	38
2.0	.0787	5.0	.1969	1.5	.0591	DDL-520	6.1	0.5	DDL-520	2.90	4.00	0.08	.003	187	59
2.5	.0984	6.0	.2362	1.8	.0709	DDL-625	7.1	0.5	DDL-625	3.80	4.93	0.08	.003	206	73
3.0	.1181	6.0	.2362	2.0	.0787	DDL-630	7.2	0.6	DDL-630	3.80	4.93	0.08	.003	206	73
3.0	.1181	7.0	.2756	2.0	.0787	DDL-730	8.1	0.5	DDL-730	4.10	5.83	0.10	.004	384	129
4.0	.1575	7.0	.2756	2.0	.0787	DDL-740	8.2	0.6	DDL-740	4.80	5.93	0.08	.003	252	106
4.0	.1575	8.0	.3150	2.0	.0787	DDL-840	9.2	0.6	DDL-840	5.20	6.93	0.10	.004	391	140
4.0	.1575	9.0	.3543	2.5	.0984	DDL-940	10.3	0.6	DDL-940	5.20	7.48	0.10	.004	641	226
4.0	.1575	10.0	.3937	3.0	.1181	DDL-1040	11.2	0.6	DDL-1040	5.80	7.96	0.15	.006	708	266
5.0	.1969	8.0	.3150	2.0	.0787	DDL-850	9.2	0.6	DDL-850	5.80	6.95	0.08	.003	274	130
5.0	.1969	9.0	.3543	2.5	.0984	DDL-950	10.2	0.6	DDL-950	6.00	7.73	0.10	.004	495	207
5.0	.1969	10.0	.3937	3.0	.1181	DDL-1050	11.2	0.6	DDL-1050	6.40	8.63	0.10	.006	714	276
5.0	.1969	11.0	.4331	3.0	.1181	DDL-1150	12.5	0.8	DDL-1150	6.40	8.63	0.15	.006	714	276
6.0	.2362	10.0	.3937	2.5	.0984	DDL-1060	11.2	0.6	DDL-1060	6.95	8.73	0.10	.004	457	194
6.0	.2362	12.0	.4724	3.0	.1181	DDL-1260	13.2	0.6	DDL-1260	7.70	9.94	0.15	.006	831	363
6.0	.2362	13.0	.5118	3.5	.1378	DDL-1360	15.0	1.0	DDL-1360	8.00	10.98	0.15	.006	1083	438
7.0	.2756	11.0	.4331	2.5	.0984	DDL-1170	12.2	0.6	DDL-1170	8.10	9.83	0.10	.004	449	199
7.0	.2756	13.0	.5118	3.0	.1181	DDL-1370	14.2	0.6	DDL-1370	8.90	11.13	0.15	.006	880	414
7.0	.2756	14.0	.5512	3.5	.1378	DDL-1470	16.0	1.0	DDL-1470	9.00	12.03	0.15	.006	1175	511
8.0	.3150	12.0	.4724	2.5	.0984	DDL-1280	13.2	0.6	DDL-1280	9.10	10.93	0.10	.004	506	249
8.0	.3150	14.0	.5512	3.5	.1378	DDL-1480	15.6	0.8	DDL-1480	9.90	12.13	0.15	.006	819	386
8.0	.3150	16.0	.6299	4.0	.1575	DDL-1680	18.0	1.0	DDL-1680	10.30	13.40	0.20	.008	1606	712
9.0	.3543	17.0	.6693	4.0	.1575	DDL-1790	19.0	1.0	DDL-1790	11.20	14.84	0.20	.008	1724	813
9.0	.3543	20.0	.7874	6.0	.2362	DDL-2090	—	—	—	12.32	16.71	0.30	.012	2123	985
10.0	.3937	19.0	.7480	5.0	.1969	DDL-1910	—	—	—	12.32	16.71	0.30	.012	2123	985
12.0	.4724	21.0	.8268	5.0	.1969	DDL-2212	—	—	—	14.40	19.22	0.30	.012	1917	1042

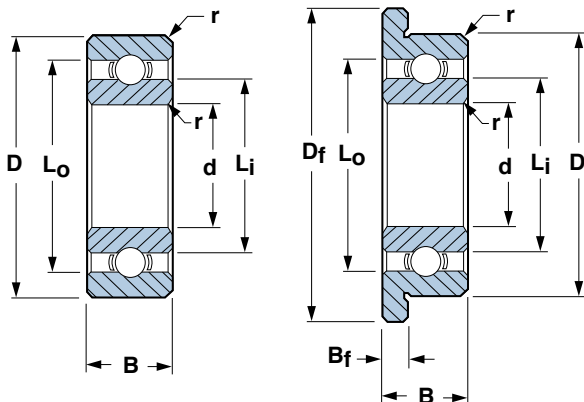

NOTES:

- Basic numbers shown above include code "DD" for NMB developed 400 series Martensitic stainless steel. If chrome steel is desired, delete "DD".
 - ABEC 1, 3, 5 and 7 tolerances apply.
 - r = Maximum shaft or housing fillet radius that bearing corners will clear.
- * "DD" is a trademark of NMB.

Radial Shielded and Flanged Shielded Bearings

BORE d		O.D. D		WIDTH B		*BASIC NUMBER	FLANGE (MM)		FLANGED *BASIC NUMBER	REFERENCE DIAMETER (MM)		FILLET RADIUS r		LOAD RATINGS N	
MM	INCH	MM	INCH	MM	INCH		DIA. D _f	WIDTH B _f		L _i	L _o	MM	INCH	DYN. C _r	STATIC C _{or}
1.5	.0591	4.0	.1575	2.0	.0787	DDL-415	—	—	—	2.15	3.42	0.05	.002	113	34
1.5	.0591	4.0	.1575	2.0	.0787	DDL-415	5.0	0.6	DDLDF-415	2.26	3.49	0.05	.002	125	38
2.0	.0787	5.0	.1969	2.3	.0906	DDL-520	6.1	0.8	DDLDF-520	2.90	4.28	0.08	.003	187	59
2.5	.0984	6.0	.2362	2.6	.1024	DDL-625	7.1	0.6	DDLDF-625	3.80	5.23	0.08	.003	206	73
3.0	.1181	6.0	.2362	2.5	.0984	DDL-630	7.2	0.8	DDLDF-630	3.80	5.23	0.08	.003	206	73
3.0	.1181	7.0	.2756	3.0	.1181	DDL-730	8.1	0.6	DDLDF-730	4.10	6.13	0.10	.004	384	129
4.0	.1575	7.0	.2756	2.5	.0984	DDL-740	8.2	0.6	DDLDF-740	4.80	6.33	0.08	.003	252	106
4.0	.1575	8.0	.3150	3.0	.1181	DDL-840	9.2	1.0	DDLDF-840	5.20	7.24	0.10	.004	391	140
4.0	.1575	9.0	.3543	4.0	.1575	DDL-940	10.3	0.8	DDLDF-940	5.20	7.93	0.10	.004	641	226
4.0	.1575	10.0	.3937	4.0	.1575	DDL-1040	11.6	0.6	DDLDF-1040	5.46	8.50	0.15	.006	708	266
5.0	.1969	8.0	.3150	2.5	.0984	DDL-850	9.2	0.6	DDLDF-850	5.80	7.26	0.08	.003	274	130
5.0	.1969	9.0	.3543	3.0	.1181	DDL-950	10.2	0.8	DDLDF-950	6.00	8.04	0.10	.004	495	207
5.0	.1969	10.0	.3937	4.0	.1575	DDL-1050	11.6	1.0	DDLDF-1050	6.40	8.94	0.10	.006	714	276
5.0	.1969	11.0	.4331	5.0	.1969	DDL-1150	12.5	0.6	DDLDF-1150	6.40	9.54	0.15	.006	714	276
6.0	.2362	10.0	.3937	3.0	.1181	DDL-1060	11.2	0.8	DDLDF-1060	6.95	9.04	0.10	.004	457	194
6.0	.2362	12.0	.4724	4.0	.1575	DDL-1260	13.6	1.1	DDLDF-1260	7.70	10.48	0.15	.006	831	363
6.0	.2362	13.0	.5118	5.0	.1969	DDL-1360	15.0	0.6	DDLDF-1360	7.33	11.44	0.15	.006	1083	438
7.0	.2756	11.0	.4331	3.0	.1181	DDL-1170	12.2	0.8	DDLDF-1170	8.10	10.14	0.10	.004	449	199
7.0	.2756	13.0	.5118	4.0	.1575	DDL-1370	14.6	1.1	DDLDF-1370	8.43	11.54	0.15	.006	880	414
7.0	.2756	14.0	.5512	5.0	.1969	DDL-1470	16.0	0.8	DDLDF-1470	9.00	12.45	0.15	.006	1175	511
8.0	.3150	12.0	.4724	3.5	.1378	DDL-1280	13.6	0.8	DDLDF-1280	9.10	11.24	0.10	.004	506	249
8.0	.3150	14.0	.5512	4.0	.1575	DDL-1480	15.6	1.1	DDLDF-1480	9.90	12.55	0.15	.006	819	386
8.0	.3150	16.0	.6299	5.0	.1969	DDL-1680	18.0	1.1	DDLDF-1680	9.68	14.18	0.20	.008	1606	712
9.0	.3543	17.0	.6693	5.0	.1969	DDL-1790	19.0	—	DDLDF-1790	11.20	15.34	0.20	.008	1724	813
9.0	.3543	20.0	.7874	6.0	.2362	DDL-2090	—	—	—	12.32	17.44	0.30	.012	2123	985
10.0	.3937	19.0	.7480	7.0	.2756	DDL-1910	—	—	—	12.32	17.44	0.30	.012	2123	985
12.0	.4724	21.0	.8268	5.0	.1969	DDL-2112	—	—	—	14.40	19.22	0.30	.012	1917	1042

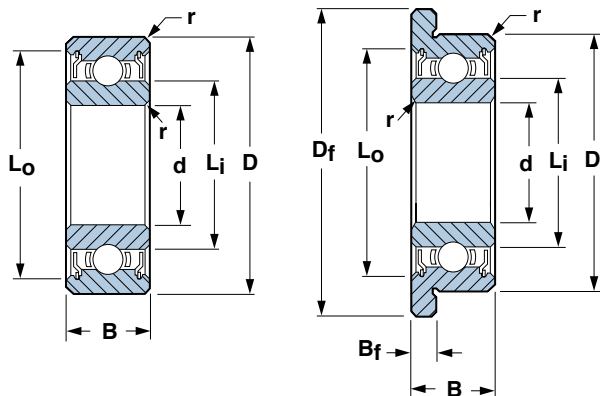

NOTES:

1. Basic numbers shown above include code "DD" for NMB developed 400 series Martensitic stainless steel. If chrome steel is desired, delete "DD".
2. ABEC 1, 3, 5 and 7 tolerances apply.
3. r = Maximum shaft or housing fillet radius that bearing corners will clear.

* "DD" is a trademark of NMB.

Radial Open and Flanged Open Bearings

BORE d		O.D. D		WIDTH B		*BASIC NUMBER	FLANGE (MM)		FLANGED *BASIC NUMBER	REFERENCE DIAMETER (MM)		FILLET RADIUS r		LOAD RATINGS N	
MM	INCH	MM	INCH	MM	INCH		DIA. D _f	WIDTH B _f		L _i	L _o	MM	INCH	DYN. C _r	STATIC C _{0r}
1.0	.0394	4.0	.1575	1.6	.0630	DDR-410	—	—	—	2.05	3.16	0.10	.004	158	44
1.2	.0472	4.0	.1575	1.8	.0709	DDR-412	—	—	—	2.05	3.16	0.10	.004	158	44
1.5	.0591	5.0	.1969	2.0	.0787	DDR-515	6.5	0.6	DDRF-515	2.60	3.73	0.15	.006	184	57
1.5	.0591	6.0	.2362	2.5	.0984	DDR-615	7.5	0.6	DDRF-615	2.90	4.73	0.15	.006	324	97
2.0	.0787	6.0	.2362	2.3	.0906	DDR-620	—	—	—	3.16	4.78	0.15	.006	279	89
2.0	.0787	6.0	.2362	2.3	.0906	—	7.5	0.6	DDRF-620	3.16	4.75	0.15	.006	330	99
2.0	.0787	7.0	.2756	2.8	.1102	DDR-720	8.5	0.7	DDRF-720	3.80	5.52	0.15	.006	330	99
2.5	.0984	7.0	.2756	2.5	.0984	DDR-725	8.5	0.7	DDRF-725	3.80	5.52	0.15	.006	380	126
2.5	.0984	8.0	.3150	2.8	.1102	DDR-825	9.5	0.7	DDRF-825	4.10	6.53	0.15	.006	553	176
3.0	.1181	8.0	.3150	3.0	.1181	DDR-830	9.5	0.7	DDRF-830	4.10	6.53	0.15	.006	553	176
3.0	.1181	9.0	.3543	3.0	.1181	DDR-930	10.5	0.7	DDRF-930	4.80	7.23	0.15	.006	634	219
3.0	.1181	10.0	.3937	4.0	.1575	DDR-1030	11.5	1.0	DDRF-1030	5.08	8.20	0.15	.006	641	226
4.0	.1575	11.0	.4331	4.0	.1575	DDR-1140	12.5	1.0	DDRF-1140	6.40	9.54	0.15	.006	714	276
4.0	.1575	12.0	.4724	4.0	.1575	DDR-1240	13.5	1.0	DDRF-1240	5.62	9.99	0.20	.008	959	347
4.0	.1575	13.0	.5118	5.0	.1969	DDR-1340	—	—	—	5.97	11.22	0.20	.008	1306	487
4.0	.1575	13.0	.5118	5.0	.1969	—	15.0	1.0	DDRF-1340	7.00	11.04	0.20	.008	1306	487
4.0	.1575	16.0	.6299	5.0	.1969	DDR-1640	18.0	1.0	DDRF-1640	7.80	13.41	0.30	.012	1735	671
5.0	.1969	13.0	.5118	4.0	.1575	DDR-1350	15.0	1.0	DDRF-1350	6.66	11.14	0.20	.008	1074	422
5.0	.1969	14.0	.5512	5.0	.1969	DDR-1450	16.0	1.0	DDRF-1450	6.88	12.14	0.20	.008	1329	508
5.0	.1969	16.0	.6299	5.0	.1969	DDR-1650	—	—	—	7.80	12.50	0.30	.012	1735	671
5.0	.1969	16.0	.6299	5.0	.1969	—	18.0	1.0	DDRF-1650	7.80	13.41	0.30	.012	1735	671
5.0	.1969	19.0	.7480	6.0	.2362	DDR-1950	—	—	—	8.67	15.63	0.30	.012	2805	1060
5.0	.1969	19.0	.7480	6.0	.2362	DDR-1950	22.0	1.5	DDRF-1950	8.67	15.60	0.30	.012	2805	1060
6.0	.2362	15.0	.5906	5.0	.1969	DDR-1560	17.0	1.2	DDRF-1560	7.80	13.20	0.20	.008	1735	671
6.0	.2362	16.0	.6299	5.0	.1969	DDR-1660	—	—	—	7.80	13.41	0.30	.012	1735	671
6.0	.2362	17.0	.6693	6.0	.2362	DDR-1760	19.0	1.2	DDRF-1760	8.22	14.70	0.30	.012	2265	839
6.0	.2362	19.0	.7480	6.0	.2362	DDR-1960	—	—	—	8.67	15.63	0.30	.012	2805	1060
6.0	.2362	19.0	.7480	6.0	.2362	—	22.0	1.5	DDRF-1960	8.67	15.63	0.30	.012	2805	1060
7.0	.2756	19.0	.7480	6.0	.2362	DDR-1970	—	—	—	9.55	16.24	0.30	.012	2240	912
7.0	.2756	22.0	.8661	7.0	.2756	DDR-2270	25.0	1.5	DDRF-2270	10.80	19.07	0.30	.012	3297	1368
8.0	.3150	19.0	.7480	6.0	.2362	DDR-1980	—	—	—	10.60	16.68	0.30	.012	2463	1059
8.0	.3150	19.0	.7480	6.0	.2362	—	22.0	1.5	DDRF-1980	9.55	16.24	0.30	.012	2240	912
8.0	.3150	22.0	.8661	7.0	.2756	DDR-2280	—	—	—	10.80	19.07	0.30	.012	3297	1368
8.0	.3150	22.0	.8661	7.0	.2756	—	25.0	1.5	DDRF-2280	10.76	18.89	0.30	.012	3297	1368
10.0	.3937	22.0	.8661	6.0	.2362	DDR-2210	—	—	—	13.40	19.40	0.30	.012	2697	1273
12.0	.4724	24.0	.9449	6.0	.2362	DDR-2412	—	—	—	14.28	21.69	0.30	.012	3082	1433

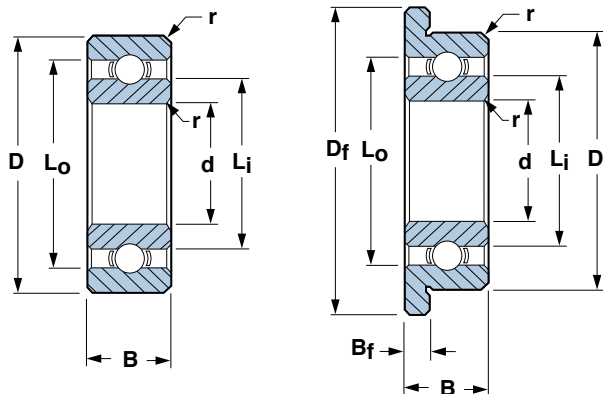

NOTES:

1. Basic numbers shown above include code "DD" for NMB developed 400 series Martensitic stainless steel. If chrome steel is desired, delete "DD".
2. ABEC 1, 3, 5 and 7 tolerances apply.
3. r = Maximum shaft or housing fillet radius that bearing corners will clear.

* "DD" is a trademark of NMB.

Radial Shielded and Flanged Shielded Bearings

BORE d		O.D. D		WIDTH B		*BASIC NUMBER	FLANGE (MM)		FLANGED *BASIC NUMBER	REFERENCE DIAMETER (MM)		FILLET RADIUS r		LOAD RATINGS N	
MM	INCH	MM	INCH	MM	INCH		DIA. D _f	WIDTH B _f		L _i	L _o	MM	INCH	DYN. C _r	STATIC C _{or}
1.5	.0591	5.0	.1969	2.0	.0787	DDR-515	6.5	0.6	DDRF-515	2.60	3.73	0.15	.006	184	57
1.5	.0591	6.0	.2362	2.5	.0984	DDR-615	7.5	0.6	DDRF-615	2.90	4.73	0.15	.006	324	97
2.0	.0787	6.0	.2362	2.3	.0906	DDR-620	7.5	0.6	DDRF-620	3.16	4.78	0.15	.006	279	89
2.0	.0787	7.0	.2756	2.8	.1102	DDR-720	8.5	0.7	DDRF-720	3.80	5.52	0.15	.006	380	126
2.5	.0984	7.0	.2756	2.5	.0984	DDR-725	8.5	0.7	DDRF-725	3.80	5.52	0.15	.006	380	126
2.5	.0984	8.0	.3150	2.8	.1102	DDR-825	9.5	0.7	DDRF-825	4.10	6.53	0.15	.006	553	176
3.0	.1181	8.0	.3150	3.0	.1181	DDR-830	9.5	0.7	DDRF-830	4.10	6.53	0.15	.006	553	176
3.0	.1181	9.0	.3543	3.0	.1181	DDR-930	10.5	0.7	DDRF-930	4.80	7.23	0.15	.006	634	219
3.0	.1181	10.0	.3937	4.0	.1575	DDR-1030	11.5	1.0	DDRF-1030	5.08	8.20	0.15	.006	641	226
4.0	.1575	11.0	.4331	4.0	.1575	DDR-1140	12.5	1.0	DDRF-1140	6.40	9.54	0.15	.006	714	276
4.0	.1575	12.0	.4724	4.0	.1575	DDR-1240	13.5	1.0	DDRF-1240	5.62	9.99	0.20	.008	959	347
4.0	.1575	13.0	.5118	5.0	.1969	DDR-1340	—	—	—	5.97	11.22	0.20	.008	1306	487
4.0	.1575	13.0	.5118	5.0	.1969	—	15.0	1.0	DDRF-1340	7.00	11.04	0.20	.008	1306	487
4.0	.1575	16.0	.6299	5.0	.1969	DDR-1640	—	—	—	7.80	13.41	0.30	.012	1735	671
4.0	.1575	16.0	.6299	5.0	.1969	—	18.0	1.0	DDRF-1640	7.80	13.20	0.30	.012	1735	671
5.0	.1969	13.0	.5188	4.0	.1575	DDR-1350	15.0	1.0	DDRF-1350	6.60	11.14	0.20	.008	1074	422
5.0	.1969	14.0	.5512	5.0	.1969	DDR-1450	16.0	1.0	DDRF-1450	6.88	12.14	0.20	.008	1329	508
5.0	.1969	16.0	.6299	5.0	.1969	DDR-1650	18.0	1.0	DDRF-1650	7.80	12.50	0.30	.012	1735	671
5.0	.1969	19.0	.7480	6.0	.2362	DDR-1950	22.0	1.5	DDRF-1950	8.67	15.63	0.30	.012	2085	1060
6.0	.2362	15.0	.5906	5.0	.1969	DDR-1560	17.0	1.2	DDRF-1560	7.80	13.20	0.20	.008	1735	671
6.0	.2362	16.0	.6299	5.0	.1969	DDR-1660	—	—	—	7.80	13.41	0.30	.012	1735	671
6.0	.2362	17.0	.6693	6.0	.2362	DDR-1760	19.0	1.2	DDRF-1760	8.22	14.70	0.30	.012	2265	839
6.0	.2362	19.0	.7480	6.0	.2362	DDR-1960	22.0	1.5	DDRF-1960	8.67	15.63	0.30	.012	2805	1060
7.0	.2756	19.0	.7480	6.0	.2362	DDR-1970	—	—	—	9.55	16.24	0.30	.012	2240	912
7.0	.2756	22.0	.8661	7.0	.2756	DDR-2270	25.0	1.5	DDRF-2270	10.80	19.07	0.30	.012	3297	1368
8.0	.3150	19.0	.7480	6.0	.2362	DDR-1980	—	—	—	10.60	16.68	0.30	.012	2463	1059
8.0	.3150	19.0	.7480	6.0	.2362	—	22.0	1.5	DDRF-1980	9.55	16.24	0.30	.012	2240	912
8.0	.3150	22.0	.8661	7.0	.2756	DDR-2280	25.0	1.5	DDRF-2280	10.80	19.07	0.30	.012	3297	1368
10.0	.3937	22.0	.8661	6.0	.2362	DDR-2210	—	—	—	13.40	19.40	0.30	.012	2697	1273
10.0	.3937	22.0	.8661	6.0	.2362	—	25.0	1.5	DDRF-2210	12.40	19.08	0.30	.012	2697	1273
12.0	.4724	24.0	.9449	6.0	.2362	DDR-2412	—	—	—	14.28	21.69	0.30	.012	3082	1433

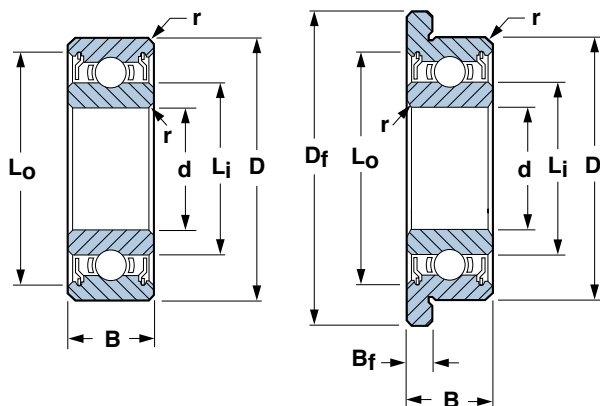

NOTES:

1. Basic numbers shown above include code "DD" for NMB developed 400 series Martensitic stainless steel. If chrome steel is desired, delete "DD".
 2. ABEC 1, 3, 5 and 7 tolerances apply.
 3. r = Maximum shaft or housing fillet radius that bearing corners will clear.
- * "DD" is a trademark of NMB.

Radial Open and Shielded Bearings

BORE d		O.D. D		WIDTH B		BASIC NUMBER	REFERENCE DIAMETER (MM)		FILLET RADIUS r		LOAD RATINGS N	
MM	INCH	MM	INCH	MM	INCH		L _o	L _i	MM	INCH	DYN. C _r	STATIC C _{or}
5	.1969	19	.7480	6	.2362	635	16.68	9.20	0.3	.012	2614	1053
6	.2362	19	.7480	6	.2362	626	16.68	9.20	0.3	.012	2614	1053
7	.2756	19	.7480	6	.2362	607	16.68	9.20	0.3	.012	2614	1053
7	.2756	22	.8661	7	.2756	627	19.10	10.80	0.3	.012	3297	1368
8	.3150	22	.8661	7	.2756	608	19.10	10.80	0.3	.012	3297	1368
9	.3543	24	0.9449	7	.2756	*609	19.10	12.40	0.3	.012	3297	1368
9	.3543	26	1.0236	8	.3150	*629	22.80	12.88	0.3	.012	4578	1970
10	.3937	26	1.0236	8	.3150	*6000	22.80	13.75	0.3	.012	4578	1970

* Note: Limited Availability

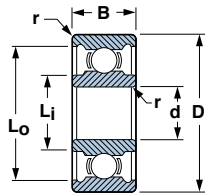

OPEN BEARING

OPEN BEARING



METAL SHIELD

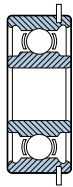

EXTERNAL
RETAINING RING
NR TYPE

NOTES:

1. Dimensions in millimeters unless otherwise noted.
2. All bearings in this series are made of chrome alloy steel.
3. r = Maximum shaft or housing fillet radius that bearing corners will clear.

Engineering Information

The information in this section will assist the design engineer in the selection of the ball bearing products that best suit critical application requirements for performance, life and cost. Early involvement by NMB Sales and Application Engineers is recommended. Engineering support services available from the company's engineering laboratories are described together with special testing capabilities.

Size, materials, component parts and lubrication alternatives are discussed in this section. These are followed by a detailed analysis of the important considerations which should be evaluated simultaneously when choosing the proper bearing for a particular design. Emphasis is also placed on the operations and aftermarket services available to the designer for installation and use of the bearings after delivery.

Engineering Services.....	4.2 - 4.3
Internal Bearing Geometry.....	4.4 - 4.5
Materials/Cages/Retainers.....	4.6
Shield and Seal Types.....	4.7 - 4.8
Lubrication.....	4.9 - 4.10
Dynamic Load Ratings and Fatigue Life.....	4.11 - 4.12
Static Capacity.....	4.13
Preloading.....	4.14 - 4.15
Packaging/Post Service Analysis.....	4.16
Quality Assurance/Dimensional Control.....	4.17 - 4.18
Temperature Conversion Table.....	4.19
Metric Conversion Table.....	4.20
Care and Handling.....	4.21 - 4.23

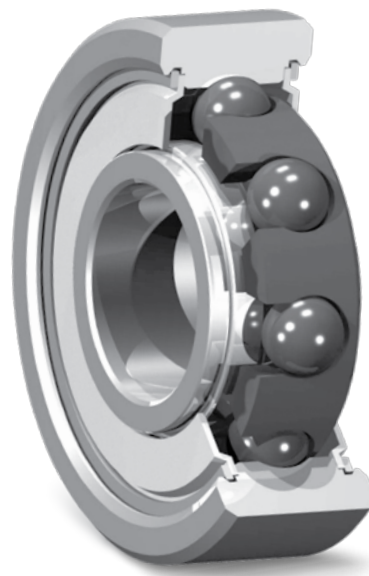

Engineering Services

Designing To Lower Cost

The majority of applications can be effectively handled using a “standard bearing.” A “standard bearing,” in this case, refers to a bearing that is in such worldwide demand that large volumes are produced. This virtually guarantees continuity of supply while assuring pricing benefits for the O.E.M. Selection of a “standard bearing” at the design stage cannot be over emphasized. The considerations necessary to design for lower cost include:

- Dimensional size
- Material type
- Lubrication
- Enclosures
- Cage style (retainer)
- Manufacturability
- Assembly and fits
- Packaging
- Quality requirements

Although different designers may vary in their approach to bearing selection, the following is one method that works well.

- Establish operating, environmental and performance requirements such as load, speed, noise, etc.
- Select a bearing configuration to meet the above requirements.

Some examples of configuration types are:

1. Flanged or unflanged
2. With or without a snap ring
3. Ball complement/size

- Determine bearing envelope to accommodate shaft and housing requirements. This step is critical to cost. It is quite often more cost effective to design the housing and shaft around a popular bearing size than vice versa.

- Specify enclosures as necessary. Be careful not to specify a more expensive enclosure than necessary to perform properly in the application.
- Specify required cage type. For the majority of cases, the standard cage for a particular chassis size will be adequate.
- Determine the bearing noise rating that is required for the application. For most cases, our standard “No Code” noise rating will provide quieter operation than most other components in the system. For extremely noise sensitive applications, a quieter noise rating can be specified.
- Determine degree of precision needed to achieve the performance requirements (ABEC Level). Do not over estimate what is truly necessary to achieve the desired performance.
- Determine the radial play specification. The standard radial play specification for a chassis size will be adequate to-handle normal press fits, moderate temperature differentials and normal speeds.
- Determine lubrication requirements. This should include lubrication characteristics and the amount of lubricant needed. This is a critical step in the performance and reliability of the bearing in the application.

Care should be taken throughout this process with respect to both cost and performance. The key in designing for the lowest total cost is to involve the Sales and Application Engineering staff early in the selection process. Costs will be impacted greatly if the envelope dimensions are not given consideration at the time of bearing selection. NMB offers an experienced Sales and Engineering staff to help in the design and selection process insuring your success.

Functional Tests For Ball Bearings

We have devised a series of rigidly monitored tests to insure that every bearing we manufacture will meet our commitment to quality and reliability. Our testing procedures measure dimensional characteristics, radial play and noise performance.

A bearing envelope and internal tolerance will not always reveal how the bearing will perform under dynamic conditions. NMB has developed "noise ratings" to assure exact bearing performance.

Every motor quality bearing produced is evaluated. During the assembly process, andersonmeters test for bearing noise and vibration. The bearings are tested under a controlled load and speed to meet their particular noise specification. This procedure allows the user to know how the bearings will perform under dynamic conditions.

Starting torque defines the effort required to initiate bearing rotation. This is a prime concern to ball bearing users. It can be a critical factor in applications requiring multiple low speed, start/stop movements.

Running torque is a measure of effort required to maintain rotation, under a certain load, after rotation has been initiated. NMB has the capability to perform running torque tests under a variety of conditions, ranging from 1-7,000 rpm with various applied thrust loads. NMB can customize tests based on specific application requirements. Tests may be fully monitored and analyzed for various ball bearing characteristics.

Accurate testing of ball bearings requires the tester to closely simulate the actual operating conditions of the intended application. Please consult an NMB Sales Engineer or a member of the Applications Engineering staff for their recommendations on the many specialized tests we can perform.

Engineering Test Laboratory

NMB maintains a fully equipped Engineering Test Laboratory where we can confirm the performance characteristics of our ball bearing designs. NMB has a full complement of commercially available equipment such as Talysurfs, Talyronds and Andersonmeters, running and starting torque testers, and real time analyzers. In addition, we have developed our own specialized state-of-the-art equipment, precisely tailored to our own requirements.

Typical of this equipment is a specially designed anechoic chamber, that includes a spindle for rotating ball bearings under loaded conditions. This can be used with a sonic analyzer to measure and record airborne noise, vibration and structureborne vibration.

Materials Laboratory

Our Materials Laboratory has been specifically designed and equipped to perform complex chemical, metallurgical, and visual analysis of the many component parts in ball bearings. Besides internal projects, this laboratory can also perform wear and failure studies on a customer's bearings.

Modern chemical analysis of organic compounds is usually carried out on a dual-beam infrared spectrophotometer. Likewise, alloy composition is determined with x-ray diffraction spectrography and non-destructive test methods.

Metallurgical studies can be done with metallograph and microhardness testers. The metallograph will perform microstructure photography at magnification from 25 to 2000 times. Micro-hardness testers investigate surface effects and alloy homogeneity using diamond indentation under loads from 1 to 10,000 grams.

During bearing inspection and failure analysis, ball bearings are disassembled and examined under a laminar flow hood. Many findings can be recorded permanently with a photo-microscope for analysis and future reference.

Internal Bearing Geometry

When designing ball bearings for optimum performance, internal bearing geometry is a critical factor. For any given bearing load, internal stresses can be either high or low, depending on the geometric relationship between the balls and raceways inside the ball bearing structure.

When a ball bearing is running under a load, force is transmitted from one bearing ring to the other through the ball set. Since the contact area between each ball and the rings is relatively small, even moderate loads can produce stresses of tens or even hundreds of thousands of pounds per square inch. Because internal stress levels have such an important effect on bearing life and performance, internal geometry must be carefully chosen for each application so bearing loads can be distributed properly.

Definitions

Raceway, Track Diameter, and Track Radius

The raceway in a ball bearing is the circular groove formed in the outside surface of the inner ring and in the inside surface of the outer ring. When the rings are aligned, these grooves form a circular track that contains the ball set.

The track diameter and track radius are two dimensions that define the configuration of each raceway. Track diameter is the measurement of the diameter of the imaginary circle running around the deepest portion of the raceway, whether it be an inner or outer ring. This measurement is made along a line perpendicular to, and intersecting, the axis of rotation. Track radius describes the cross section of the arc formed by the raceway groove. It is measured when viewed in a direction perpendicular to the axis of the ring. In the context of ball bearing terminology, track radius has no mathematical relationship to track diameter. The distinction between the two is shown in Figure 1.

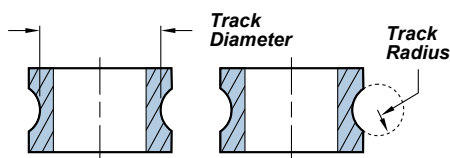

Figure 1. The distinction between track radius and track diameter (inner ring).

Radial and Axial Play

Most ball bearings are assembled in such a way that a slight amount of looseness exists between balls and raceways. This looseness is referred to as radial play and axial play. Specifically, radial play is the maximum distance that one bearing ring can be displaced with respect to the other, in a direction perpendicular to the bearing axis, when the bearing is in an unmounted state. Axial play, or end play, is the maximum relative displacement between the two rings of an unmounted ball bearing in the direction parallel to the bearing axis. Figure 2 illustrates these concepts.

Since radial play and axial play are both consequences of the same degree of looseness between the components in a ball bearing, they bear a mutual dependence. While this is true, both values are usually quite different in magnitude.

In most ball bearing applications, radial play is functionally more critical than axial play. If axial play is determined to be an essential requirement, control can be obtained through manipulation of the radial play specification. Please consult with Application Engineering if axial play ranges for a particular chassis size are required.

Some general statements about Radial Play:

1. The initial contact angle of the bearing is directly related to radial play- the higher the radial play, the higher the contact angle. The chart on the following page gives nominal values under no load.
2. For support of pure radial loads, a low level of radial play is desirable; where thrust loading is predominant, higher radial play levels are recommended.
3. Radial play is affected by any interference fit between the shaft and bearing I.D. or between the housing and bearing O.D.

If the system spring rate is critical, or if extremes of temperature or thermal gradient will be encountered, consult with our Engineering Department prior to design finalization.

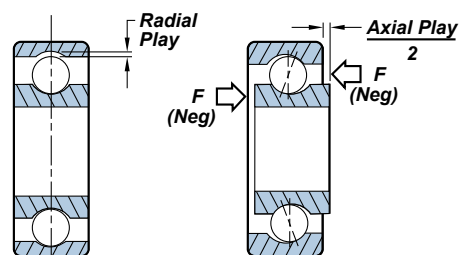

Figure 2. The distinction between radial play and axial play.

Table Of Contact Angles α_o

Ball Size D_w	RADIAL PLAY CODE	
	P25	P58
.025	18°	24 1/2°
1/32 & 0.8 mm	16 1/2°	22°
1 mm	14 1/2°	20°
3/64	14°	18°
1/16	12°	16°
3/32	9 1/2°	13°
1/8	12 1/2°	17°
9/64	12°	16°
5/32	11°	15°
3/16	10°	14°

The contact angle is given for the mean radial play of the range shown i.e., for P25 (.0002" to .0005") contact angle is given for .00035". Contact angle is affected by race curvature. For your specific application, contact NMB Engineering.

Typical radial play ranges are:

Description	Radial Play Range	NMB Code
Tight	.0001" to .0003"	P13
Normal	.0002" to .0005"	P25
Loose	.0005" to .0008"	P58

Raceway Curvature

Raceway curvature is an expression that defines the relationship between the arc of the raceway's track radius and the arc formed by the slightly smaller ball that runs in the raceway. It is simply the track radius of the bearing raceway expressed as a percentage of the ball diameter. This number is a convenient index of "fit" between the raceway and ball. Figure 3 illustrates this relationship.

Track curvature values typically range from approximately 52 to 58 percent. The lower percentage, tight fitting curvatures are useful in applications where heavy loads are encountered. The higher percentage, loose curvatures are more suitable for torque sensitive applications. Curvatures less than 52 percent are generally avoided because of excessive rolling friction that is caused by the tight conformity

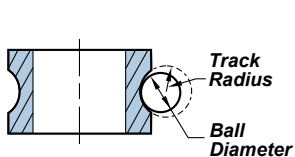

Figure 3. The relationship of track radius to ball diameter.

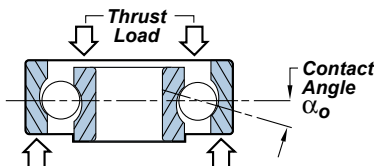

Figure 4. Contact angle for bearing loaded in pure thrust.

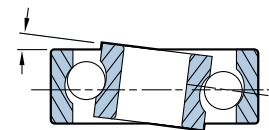

Figure 5. Free angle of the bearing.

between the ball and raceway. Values above 58 percent are also avoided because of the high stress levels that can result from the small ball-to-raceway conformity at the contact area.

Contact Angle

The contact angle is the angle between a plane perpendicular to the ball bearing axis and a line joining the two points where the ball makes contact with the inner and outer raceways. The contact angle of a ball bearing is determined by its free radial play value, as well as its inner and outer track curvatures.

The contact angle of thrust-loaded bearings provides an indication of ball position inside the raceways. When a thrust load is applied to a ball bearing, the balls will move away from the median planes of the raceways and assume positions somewhere between the deepest portions of the raceways and their edges. Figure 4 illustrates the concept of contact angle by showing a cross sectional view of a ball bearing that is loaded in pure thrust.

Free Angle and Angle of Misalignment

As a result of the previously described looseness, or play, which is purposely permitted to exist between the components of most ball bearings, the inner ring can be cocked or tilted a small amount with respect to the outer ring. This displacement is called the free angle of the bearing, and corresponds to the case of an unmounted bearing. The size of the free angle in a given ball bearing is determined by its radial play and track curvature values. Figure 5 illustrates this concept.

For the bearing mounted in an application, any misalignment present between the inner and outer rings (housing and shaft) is called the angle of misalignment. The misalignment capability of a bearing can have positive practical significance because it enables a ball bearing to accommodate small dimensional variations which may exist in associated shafts and housings. A maximum angle of misalignment of 1/4° is recommended before bearing life is reduced. Slightly larger angles can be accommodated, but bearing life will not be optimized.

Materials/Cages/Retainers

Bearing Materials

Chrome Steel

Bearing steel used for standard ball bearing applications in uses and in environments where corrosion resistance is not a critical factor.

52100 or Equivalent

The most commonly used ball bearing steel in such applications as SAE 52100 or its equivalent. Due to its structure, this is the material chosen for extreme noise sensitive applications.

Stainless Steel

DD400™ 0.7% C; 13% Cr

A 400 series Martensitic stainless steel combined with a heat treating process was exclusively developed by NMB's parent company. Miniature and instrument bearings manufactured from "DD™" Martensitic stainless steel, or "DD Bearings™", meet the performance specifications of such bearings using AISI 440C Martensitic stainless steel, and it is equal to or superior in hardness, superior in low noise characteristics, and is at least equivalent in corrosion resistance. These material characteristic advantages make for lower torque, smoother running, and longer life bearings.

The retainer, also referred to as the cage or separator, is the component part of a ball bearing that separates and positions the balls at approximately equal intervals around the bearing's raceway. There are two basic types that we supply: the crown or open end design and the ribbon or closed ball pocket design. The most common retainer is the two-piece closed pocket metal ribbon retainer.

The Open End design, or crown retainer, as shown in Figure 1 is of metal material. The metal retainer, constructed of hardened stainless steel, is very light-weight and has coined ball pockets which present a hard, smooth, low-friction contact surface to the balls. A feature of this assembly is

its smooth running characteristic. Crown retainers manufactured from molded plastics are available for some sizes. Plastic molded nylon retainers are advantageous when application speeds are high relative to the particular bearing used. For special retainer requirements, please consult a member of our Sales-Engineering or Applications Engineering Department.

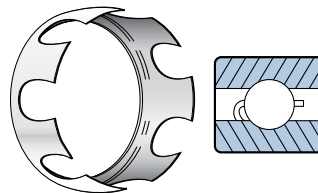

Figure 1. Standard one-piece crown retainer.

Closed Pocket Design (two-piece construction). The two-piece closed pocket design, as outlined in Figure 2 with clinching tabs, is our standard design for most miniature and instrument size ball bearings. The use of loosely clinched tabs is favorable for starting torque, and the closed pocket design provides good durability required for various applications.

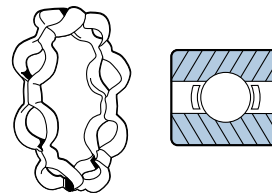

Figure 2. Two-piece closed pocket metal ribbon retainer.

For special retainer requirements, please consult a member of our Sales Engineering or Applications Engineering Department.

Shields and Seal Types

Shields and seals are necessary to provide optimum ball bearing life by retaining lubricants and preventing contaminants from reaching central work surfaces. NMB can manufacture ball bearings with several types of protective closures that have been designed to satisfy the requirements of most applications. Different types of closures can be supplied on the same bearing and nearly all are removable and replaceable. They are manufactured with the same care and precision that goes into our ball bearings. The following are descriptions of the most common types of shields and seals we can supply. Please consult a member of the company's Sales Engineering or Applications Engineering staff for information on the availability of special designs that may be suited to your specific applications.

K, Z & H Type Shields

"K", "Z" and "H" type shields designate non-contact metal shields. "Z" type shields are the simplest form of closure and, for most bearings, are removable. "K" and "H" type shields are similar to "Z" types but are not removable.

It is advantageous to use shields rather than seals in some applications because there are no interacting surfaces to create drag. This results in no appreciable increase in torque or speed limitations and operation can be compared to that of open ball bearings.

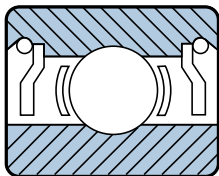

Figure 1. Two "Z" Shields (removable)

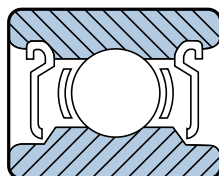

Figure 2. Two "H" Shields (non-removable)

Contact Seals

"D" type seals consist of a molded Buna-N lip seal with an integral steel insert. While this closure type provides excellent sealing characteristics, several factors must be considered for its application. The material normally used on this seal has a maximum continuous operating temperature limit of 250°F. Although it is impervious to many oils and greases, consideration must be given to lubrication selection. It is also capable of providing a better seal than most other types by increasing the seal lip pressure against the inner ring O.D. This can result in a higher bearing torque than with other type seals and may cause undesirable seal lip heat build-up in high speed applications.

The DSD64 and the DSD21 type seals have the same operating characteristics as the "D" type seal, resulting in the same considerations of temperature limitations and lubricant selection. The DSD64 seal is comprised of a double-lip contact rubber seal with a stepped inner ring similar to the "D" type seal. The double-lip contact design configuration offers additional protection from extreme environments such as liquid contamination or high-pressure drops across the bearing. The DSD21 type seal is comprised of a contact rubber seal combined with a labyrinth designed inner ring. The labyrinth design configuration creates an extended path to the raceway, combined with a contact seal, minimizes the tendency for contaminants to enter the bearing.

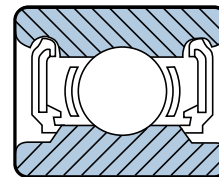

Figure 3. Two "D" Seals (contact rubber)

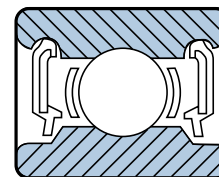

Figure 4. Two "S" Seals (non-contact rubber)

Shields and Seal Types *(continued)*

Non-Contact Seals

“S” type seals are constructed in the same fashion as the “D” type seals. This closure type has the same temperature limitation of 250°F. It also is impervious to many oils and greases, but the same considerations should be noted on lubrication selection. The “S” type seal is uniquely designed to avoid contact on the inner ring land, significantly reducing torque over the “D” type configuration.

“L” type seals are fabricated from glass re-inforced teflon. When assembled, a very small gap exists between the seal lip and the inner ring O.D. It is common for some contact to occur between these components, resulting in an operating torque increase. The nature of the seal material serves to keep this torque increase to a minimum. In addition, the use of this material allows high operating temperatures with this configuration.

The SSD21 type seals have the same operating characteristics as the “D” and “S” type seals, resulting in the same considerations of temperature limitation and lubricant selection. The SSD21 type seal is comprised of a non-contact rubber seal combined with a labyrinth designed inner ring, while the DSD21 type seal is the contact seal version with the labyrinth inner ring. The labyrinth design configuration creates an extended path to the raceway minimizing the tendency for contaminants to creep into the ball bearing.

If you have any questions concerning the performance of NMB Technologies Corporation seals in special environments or high speed applications, please contact a member of our Sales Engineering or Applications Engineering staff.

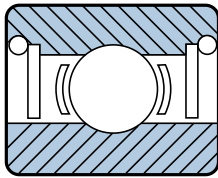

**Figure 5. Two “L” Seals
(non-flexed teflon)**

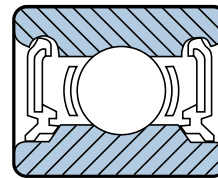

**Figure 7. Two “DSD64”
Double-lip Seals**

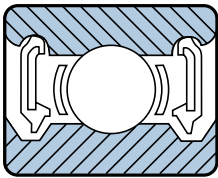

**Figure 6. Two “SSD21” Seals
(labyrinth design seal)**

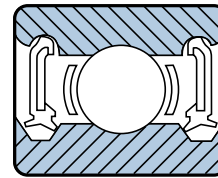

**Figure 8. Two “DSD21”
Labyrinth Seals
(light contact)**

Lubrication

Lubricant Types

Oil

Oil is the basic lubricant for ball bearings. Previously most lubricating oil was refined from petroleum. Today, however, synthetic oils such as diesters, silicone polymers, and fluorinated compounds have found acceptance because of improvements in properties. Compared to petroleum base oils, diesters in general have better low temperature properties, lower volatility, and better temperature/viscosity characteristics. Silicones and fluorinated compounds possess even lower volatility and wider temperature/viscosity properties.

Virtually all petroleum and diester oils contain additives that limit chemical changes, protect the metal from corrosion, and improve physical properties.

Grease

Grease is an oil to which a thickener has been added to prevent oil migration from the lubrication site. It is used in situations where frequent replenishment of the lubricant is undesirable or impossible. All of the oil types mentioned in the next section can be used as grease bases to which are added metallic soaps, synthetic fillers and thickeners. The operative properties of grease depend almost wholly on the base oil. Other factors being equal, the use of grease rather than oil results in higher starting and running torque and can limit the bearing to lower speeds.

Oils and Base Fluids

Petroleum Mineral Lubricants

Petroleum lubricants have excellent load carrying abilities and are naturally good against corrosion, but are useable only at moderate temperature ranges (-25° to 250°F). Greases of this type would be recommended for use at moderate temperatures, light to heavy loads and moderate to high speeds.

Super-Refined Petroleum Lubricants

While these lubricants are usable at higher temperatures than petroleum oils (-65° to 350°F), they still exhibit the same excellent load carrying capacity. This further refinement eliminates unwanted properties, leaving only the desired chemical chains. Additives are introduced to increase the oxidation resistance, etc.

Synthetic Lubricants

The esters, diesters and poly- α -olefins are probably the most common synthetic lubricants. They do not have the film strength capacity of a petroleum product, but do have a wide temperature range (-65° to 350°F) and are oxidation resistant.

Synthetic hydrocarbons are finding a greater use in the miniature and instrument ball bearing industry because they have proved to be a superior general purpose lubricant for a variety of speeds, temperatures and environments.

Silicone Lubricants

Silicone products are useful over a much wider temperature range (-100° to 400°F), but do not have the load carrying ability of petroleum types and other synthetics.

Perfluorinated Polyether (PFPE)

Oils and greases of this type have found wide use where stability at extremely high temperatures and/or chemical inertness are required. This specialty lubricant has excellent load carrying capabilities but its inertness makes it less compatible to additives, and less corrosion resistant.

Lubrication *(continued)*

Lubrication Methods

Grease packing to approximately one quarter to one third of a ball bearing's free volume is one of the most common methods of lubrication. Volumes can be controlled to a fraction of a percent for precision applications by special lubricators. In some instances, customers have requested that bearings be lubricated 100% full of grease. Excessive grease, however, is as detrimental to a bearing as insufficient grease. It causes shearing, heat buildup, unnecessarily high torque, and deterioration through constant churning which can ultimately result in bearing failure.

Centrifuging an oil lubricated bearing removes excess oil and leaves only a very thin film on all surfaces. This method is used on very low torque bearings and can be specified by the customer for critical applications.

There are many lubricants available for ball bearings. The chart below lists a variety of types, one of which should work well for most operating conditions.

Table of Commonly Used Lubricant Types

Grease Type	Lithium Soap Grease			Urea Grease		Fluorinated Grease				Conductive Grease			Oil	
Thickener	Lithium Soap			Urea		PTFE				Carbon			-	
Base Oil	Ester			Synthetic Hydro-carbon	Ester	Fluorinated			Fluori-nated + Ester	Synthetic Hydrocarbon			Ester	Synthetic Hydro-carbon
NMB Code	LY121	LY72	LY552	LY551	LY532	LY500	LY586	LY699	LY655	LY727	LY707	LY722	LOI	LY650
Base Oil Viscosity [mm ² /s@40° C]	26	15	55	48	100	190	85	210	85	148	420	20	12	32
Worked Penetration*	250	275	240	225	255	280	280	280	280	235	263	263	-	-
Temperature Range** [°C]	-50 +150	-50 +150	-40 +130	-40 +200	-40 +180	-50 +260	-50 +220	-40 +200	-50 +200	-40 +125	-40 +125	-40 +125	-50 +120	-40 +130

* These values shown are typical.

** These ranges are based on information provided by each grease manufacturer. Please note that they are not the specific temperature ranges for ball bearing applications.

Application Guide

NMB Code	LY121	LY72	LY552	LY551	LY532	LY500	LY586	LY699	LY655	LY727	LY707	LY722	LOI	LY650
Noise	BETTER	BETTER	BETTER	BETTER	FAIR	FAIR	GOOD	GOOD	FAIR	POOR	POOR	POOR	BETTER	BETTER
Torque	BETTER	BETTER	GOOD	GOOD	FAIR	FAIR	BETTER	BEST	FAIR	FAIR	POOR	FAIR	BETTER	BETTER
High Temperature	GOOD	FAIR	BETTER	BETTER	BETTER	BEST	BEST	BEST	BEST	BETTER	BEST	GOOD	FAIR	FAIR
Low Temperature	GOOD	BETTER	GOOD	GOOD	FAIR	FAIR	BETTER	BEST	FAIR	GOOD	GOOD	GOOD	BETTER	BETTER
High Speed	GOOD	FAIR	GOOD	BETTER	BETTER	FAIR	FAIR	FAIR	FAIR	FAIR	FAIR	FAIR	FAIR	FAIR
Plastic Compatability	POOR	POOR	POOR	BETTER	POOR	FAIR	-	-	BETTER	BETTER	-	-	POOR	BETTER
Cost Performance	BETTER	BETTER	GOOD	BETTER	GOOD	POOR	POOR	POOR	FAIR	FAIR	POOR	FAIR	FAIR	GOOD

Dynamic Load Ratings and Fatigue Life

Dynamic Radial Load Rating

The dynamic radial load rating (C_r) for a radial ball bearing is a calculated, constant radial load which a group of identical bearings can theoretically endure for a rating life of one million revolutions. The dynamic radial load rating is a reference value only. The base value of one million revolutions Rating Life has been chosen for ease of calculation. Since applied loading equal to the basic load rating tends to cause permanent deformation of the rolling surfaces, such excessive loading is not normally applied. Typically, a radial load that corresponds to 15 percent, or more, of the dynamic radial load rating is considered heavy loading for a ball bearing. In cases where loading of this degree is required, please consult an NMB Application Engineer for information regarding bearing life and lubricant recommendations.

The dynamic radial load rating (C_r) can be found on the product listing pages. The dynamic equivalent load must be calculated according to the following procedure:

$$P_r = XF_r + YF_a$$

Where

P_r = Dynamic equivalent radial load (N)

X, Y = Obtained from the following X and Y table

F_r = Radial load on the bearing during operation (N)

F_a = Axial load on the bearing during operation (N)

The L_{10} life can be converted from millions of revolutions to hours using the rotation speed. This can be done as follows:

$$L_{10} \text{ (millions of revolutions)} \times \frac{1,000,000}{\text{RPM} * 60} = L_{10} \text{ (hours)}$$

Rating Life

The “rating life” (L_{10}) of a group of apparently identical ball bearings is the life in millions of revolutions, or number of hours, that 90 percent of the group will complete or exceed. For a single bearing, L_{10} also refers to the life associated with 90 percent reliability. The life which 50 percent of the group of ball bearings will complete or exceed (“median life” L_{50}) is usually not greater than five times the rating life.

Calculation of Rating Life:

The magnitude of the rating life, L_{10} , in millions of revolutions for a ball bearing application is

$$L_{10} = \left(\frac{C_r}{P_r} \right)^3$$

Where

L_{10} = Rating life as described above

C_r = Dynamic radial load rating (N)

P_r = Dynamic equivalent radial load (N)

Relative Axial Load $\frac{F_a}{Z^2 D_w}$	e	$F_a/F_r \leq e$		$F_a/F_r \geq e$	
		X	Y	X	Y
0.172	0.19				2.30
0.345	0.22				1.99
0.689	0.26				1.71
1.03	0.28				1.55
1.38	0.30	1	0	0.56	1.45
2.07	0.34				1.31
3.45	0.38				1.15
5.17	0.42				1.04
6.89	0.44				1.00

Z = Number of balls D_w = Ball size (mm)

Step 1:

Calculate F_a/ZD_w^2 and cross reference value “e”.

Step 2:

Determine F_a/F_r relationship to find X and Y values.

Dynamic Load Ratings and Fatigue Life *(continued)*

Life Modifiers

For most cases, the L_{10} life obtained from the equation discussed previously will be satisfactory as a bearing performance criterion. However, for particular applications, it might be desirable to consider life calculations for different reliabilities and/or special bearing properties and operating conditions. Reliability adjustment factors, bearing material adjustment, and special operating conditions are discussed below. For assistance with questions regarding bearing life, please consult an NMB Applications Engineer.

Bearing Material

Radial load ratings published are for chrome and stainless (DD) steel.

Reliability Modifier

Where a more conservative approach than conventional rating life (L_{10}) is desired, the ABMA offers a means for such estimates. The table below provides selected modifiers (a_2) for calculating failure rates down to 1% (L_1).

Table of Reliability/Material Life Modifier a_2

Required Reliability -%	L_n	Value of a_2
		Chrome or DD
90	L_{10}	1.00
95	L_5	0.62
96	L_4	0.53
97	L_3	0.44
98	L_2	0.33
99	L_1	0.21



Static Capacity

Other Life Adjustments

The conventional rating life often has to be modified as a consequence of application abnormalities, whether they be intentional or unknown. Seldom are loads ideally applied. The following conditions all have the practical effect of modifying the ideal, theoretical rating life (L_{10}).

- Vibration and/or shock-impact loads
- Angular misalignment
- High-speed effects
- Operation at elevated temperatures
- Fits
- Internal design

NMB can assist in gauging the impact of these conditions when they are of a major concern to the application. Please consult an NMB Sales Engineer or a member of the Applications Engineering staff.

Oscillatory Service Life

Frequently, ball bearings do not operate with one ring rotating unidirectionally. Instead, they execute a partial revolution, reverse motion, and then repeat this cycle, most often in a uniform manner. Efforts to forecast a reliable fatigue life by simply relating oscillation rate to an “equivalent” rotational speed are invalid. The actual fatigue life of bearings operating in the oscillatory mode is governed by four factors; these factors are: applied load, angle of oscillation, rate of oscillation, and lubricant. NMB can provide guidance on practical life of ball bearings in oscillatory applications.

Lubricant Life

In many instances a bearing’s effective life is governed by the lubricant’s life. This is usually the case where applications involve very light loads and/or very slow speeds.

With light loads and/or slow speeds the conventional fatigue life forecast will be unrealistically high. The lubricant’s ability to provide sufficient film strength is sustained only for a limited time. This is governed by:

- Quality and quantity of the lubricant in the bearing
- Environmental conditions
(i.e., ambient temperature, area cleanliness)

- The load-speed cycle

Specialized oils and greases are available that exhibit favorable properties over an extended period. Please consult an NMB Sales Engineer or a member of the Applications Engineering staff for guidance on practical lubricant life.

Static Radial Load Rating

The static radial load rating (C_{or}) given on the product listing pages is the radial load which a non-rotating ball bearing will support without damage, and will continue to provide satisfactory performance and life.

The static radial load rating is dependent on the maximum contact stress between the balls and either of the two raceways. The load ratings shown were calculated in accordance with the ABMA standard. The ABMA has established the maximum acceptable stress level resulting from a pure radial load, in a static condition, to be 4.2 GPa (609,000 psi).

Static Axial Load Capacity

The static axial load capacity is axial load which a non-rotating ball bearing will support without damage. The axial static load capacity varies with bearing size, bearing material, and radial play. Due to the multiple combinations possible for each bearing, the axial static load capacities are not listed in this catalog. For information regarding axial load capacities, please consult an NMB Sales Engineer or Applications Engineer.

High Static Loads

NMB can provide specific recommendations for extraordinary high static load applications. Please consult a member of our Sales Engineering or Applications Engineering staff.

Preloading

Ball bearing systems are preloaded:

1. To eliminate radial and axial looseness.
2. To reduce operating noise by stabilizing the rotating mass.
3. To control the axial and radial location of the rotating mass and to control movement of this mass due to external force influences.
4. To reduce the repetitive and non-repetitive runout of the rotational axis.
5. To reduce the possibility of damage due to vibratory loading.
6. To increase stiffness.

Spindle motors and tape guides are examples of applications where preloaded bearings are used to accurately control shaft position when external loads are applied. As the name implies, a preloaded assembly is one in which a bearing load (normally a thrust load) is applied to the system so the bearings are already carrying a load before any external load is applied.

There are essentially two ways to preload a ball bearing system - by using a spring and by a solid stack of parts.

Spring Preloading

For many applications, one of the simplest and most effective methods of applying a preload is by means of a spring. This can consist of a coil spring or perhaps a wavy washer which applies a force against the inner or outer ring of one of the bearings in an assembly.

When a spring is used, it is normally located on the non-rotating component; i.e., with shaft rotation, the spring should be located in the housing against the outer rings. Springs can be very effective where differential thermal expansion is a problem. In the spindle assembly (Figure 1), when the shaft becomes very hot and expands in length, the spring will move the outer ring of the left bearing and thus maintain system preload. Care must be taken to allow for enough spring movement to accommodate the potential shaft expansion.

Since, in a spring, the load is fairly consistent over a wide range of compressed length, the use of a spring for preloading negates the necessity for holding tight location tolerances on machined parts. For example, retaining rings can be used in the spindle assembly, thus saving the cost of locating shoulders, shims, or threaded members.

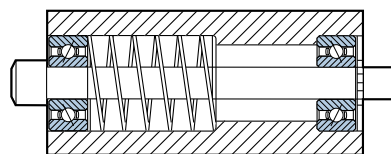

Figure 1. Spindle Assembly using compression coil spring — shaft rotation

Normally, a spring preload would **not** be used where the assembly is required to withstand reversing thrust loads.



Preloading (continued)

Solid Stack Preloading

Where precise location control is required, as in a precision motor (Figure 2) or a flanged tape guide (Figure 3), a solid preload system is indicated.

A solid stack, “hard” or “rigid” preload, can be achieved in a variety of ways. Theoretically, it is possible to preload an assembly by tightening a screw as shown (Figure 3) or inserting shims (Figure 4) to obtain the desired rigidity. It should be noted that care must be taken when using a solid stack preloading system with miniature and instrument bearings. Overload of the bearings must be avoided so that the bearings are not damaged during this process.

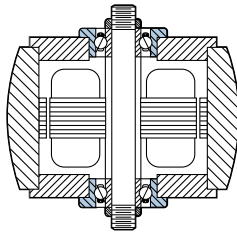

Figure 2. Typical Motor design using rotor as outer ring spacer and stator mount as inner ring spacer – outer ring rotation – Solid preload

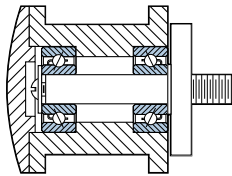

Figure 3. Typical Tape Guide design using screw and washer to solidly preload by clamping inner rings – Outer Ring Rotation

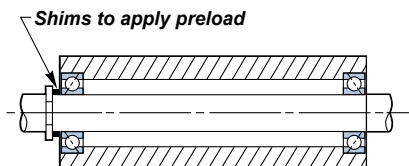

Figure 4.

Preload Levels

Preloading is an effective means of positioning and controlling stiffness because of the nature of the ball/raceway contact. Under light loads, the ball/raceway contact area is very small and so the amount of “yield” or “definition” is substantial with respect to the amount of load. As the load is increased, the ball/raceway contact area increases in size (the contact is in the shape of an ellipse) and so provides increased stiffness or reduced “yield” per unit of applied load.

Application Engineers at NMB can provide assistance in selecting appropriate preload specifications and in providing specific information on bearing yield rates where that is required.

Packaging/Post Service Analysis

Our bearings are normally packaged in plastic vials or cardboard packaging. For chrome bearings, if prelubrication or protective coating is not specified by the applicable drawing or order, a preservative oil will be used to prevent corrosion.

Other special types of packaging to suit specific needs will be considered. Check with our Engineering Department when questions or special requirements arise.

Our Engineering staff stands ready to perform post service analysis on any bearings that have been in actual use. If bearings have failed in service, it is frequently possible to determine the cause of failure by examining parts and debris, even though the failure was catastrophic. All of the bearing components and as much as possible of the assembly in which they ran, should be made available for examination by our engineers. For example, if a small motor fails on life test, send the complete motor, assembled just as it came off the test bench, to us. A complete detailed examination will be made and a written report submitted. The report will contain details of the condition of bearings and mating parts, including actual measurements where applicable, and specific recommendations for overall improvement of the bearing performance in this particular application. Even if no failure occurs and particularly when units have been in actual field service for a long period of time, a wealth of valuable information and data can frequently be accumulated from post service analysis. This information can be very useful in product improvement and cost reduction programs.

The keys to gaining useful information from post service analysis are:

- Availability of the undisturbed assembled device, or as many components as possible, and
- Availability of as much historical information as possible describing the conditions under which the device operated. Speeds, loads, temperature, atmospheric conditions, any unusual shock, vibration or handling situations, etc., should be noted for consideration when the parts are examined.

When a failure occurs, or better yet, when a significantly successful test or field unit is obtained, contact us prior to tear-down to make arrangements for a post service analysis that may help you in your product improvement efforts.



Quality Assurance & Dimensional Control

NMB Quality Control Systems meet ISO 9001 Standards.

In addition to the normal incoming material, first article, lot and in-process component inspections, the QC Department maintains process surveillance on all production operations particularly heat treat, deburring, grinding, and race finishing. This is to ensure that these operations, which generate the characteristics of the finished product, remain in control at all times.

The company has equipped the Quality Assurance Department with the latest and finest test and measurement equipment available. Roundness, and concentricity are measured.

Every bearing is guaranteed to be free of defects in workmanship and materials for twelve (12) months from invoice date. Any bearing found defective within the warranty period may be repaired, replaced or the purchase price repaid, provided that it is returned to the company and, upon inspection, is found to have been properly mounted, lubricated, protected and not subjected to any mishandling.

NMB follows the specifications of the American Bearing Manufacturers Association (ABMA) and its associated ball bearing technical committee, the Annular Bearing Engineers' Committee (ABEC).

The ABEC tolerances on the next page are current at this catalog's printing. These tolerances are reviewed regularly and updated as required. The ABMA Standards may be obtained by contacting: ABMA, 2025 M Street, NW, Suite 800, Washington, DC 20036. All dimensions are in inches.

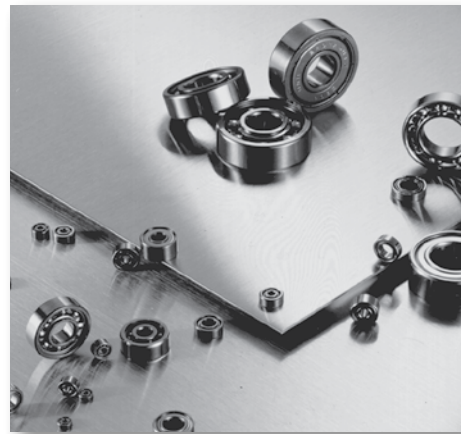
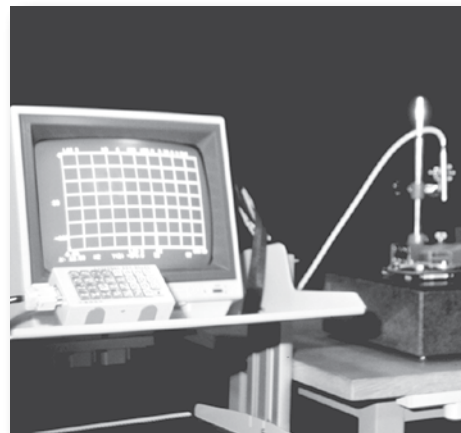

Tolerances: Miniature and Instrument Ball Bearings Inner Ring

Characteristic	ABEC 1	ABEC 3	ABEC 5	ABEC 7
Mean Bore Tolerance Limits	+0.000 -0.003	+0.0000 -0.0002	+0.0000 -0.0002	+0.0000 -0.0002
Radial Runout Width Variation	.0003 (1) —	.0002 (1) —	.00015 .00020	.0001 .0001
Bore Runout with Face	—	—	.00030	.0001
Race Runout with Face	—	—	.00030	.0001

(1) Add .0001 to the tolerance if bore size is over 10mm (.3937 inch).

Outer Ring

Characteristic	Configuration	Size Range	ABEC 1	ABEC 3	ABEC 5	ABEC 7
Mean O.D. Tolerance Limits	All	0-18mm (0-.709)	+0.000 -0.003	+0.0000 -0.0003	+0.0000 -0.0002	+0.0000 -0.0002
	All	over 18-30mm (.709-1.1811)	+0.0000 -0.00035	+0.0000 -0.0003	+0.0000 -0.0002	+0.0000 -0.0002
Radial Runout	All	0-18mm	.0006	.0004	.0002	.00015
Width Variation	All	over 18-30mm	.0006	.0004	.0002	.00015
O.D. Runout with Face	All	0-30mm	—	—	.0002	.00010
Race Runout with Face	All	0-30mm	—	—	.0003	.00015
Race Runout with Face	Plain	0-18mm	—	—	.0003	.00020
	Plain	over 18-30mm	—	—	.0003	.00020
	Flanged	0-30mm	—	—	.0003	.00030
Flange Width Tolerance Limits	—	—	—	+0.0000	+0.0000	+0.0000
	—	—	—	-0.0020	-0.0020	-0.0020
Flange Diameter Tolerance Limits	—	—	—	+0.0050	+0.0000	+0.0000
	—	—	—	-0.0020	-0.0010	-0.0010

Ring Width

Characteristic	ABEC 1	ABEC 3	ABEC 5	ABEC 7
Width Tolerance	+0.000 -0.005	+0.000 -0.005	+0.000 -0.001	+0.000 -0.001

Temperature Conversion Table

The numbers in the center column refer to the temperatures either in Celsius or Fahrenheit which need conversion to the other scale. When converting from Fahrenheit to Celsius, the equivalent temperature will be found to the left of the center column. If converting from Celsius to Fahrenheit the answer will be found to the right.

°C	°C/°F	°F	°C	°C/°F	°F	°C	°C/°F	°F	°C	°C/°F	°F
-79	-110	-166	37.7	100	212	204	400	752	371	700	1292
-73	-100	-148	43	110	230	210	410	770	376	710	1310
-68	-90	-130	49	120	248	215	420	788	382	720	1328
-62	-80	-112	54	130	266	221	430	806	387	730	1346
-57	-70	-94	60	140	284	226	440	824	393	740	1364
-51	-60	-76	65	150	302	232	450	842	565	1050	1922
-46	-50	-58	71	160	320	238	460	860	571	1060	1940
-40	-40	-40	76	170	338	243	470	878	576	1070	1958
-34	-30	-22	83	180	356	249	480	896	582	1080	1976
-29	-20	-4	88	190	374	254	490	914	587	1090	1994
-23	-10	14	93	200	392	260	500	932	593	1100	2012
-17.7	0	32	99	210	410	265	510	950	598	1110	2030
-17.2	1	33.8	104	220	428	271	520	968	604	1120	2048
-16.6	2	35.6	110	230	446	276	530	986	609	1130	2066
-16.1	3	37.4	115	240	464	282	540	1004	615	1140	2084
-15.5	4	39.2	121	250	482	288	550	1022	620	1150	2102
-15.0	5	41.0	127	260	500	293	560	1040	626	1160	2120
-14.4	6	42.8	132	270	518	299	570	1058	631	1170	2138
-13.9	7	44.6	138	280	536	304	580	1076	637	1180	2156
-13.3	8	46.4	143	290	554	310	590	1094	642	1190	2174
-12.7	9	48.2	149	300	572	315	600	1112	648	1200	2192
-12.2	10	50.0	154	310	590	321	610	1130	653	1210	2210
-6.6	20	68.0	160	320	608	326	620	1148	659	1220	2228
-1.1	30	86.0	165	330	626	332	630	1166	664	1230	2246
4.4	40	104.0	171	340	644	338	640	1184	670	1240	2264
9.9	50	122.0	177	350	662	343	650	1202	675	1250	2282
15.6	60	140.0	182	360	680	349	660	1220	681	1260	2300
21.0	70	158.0	188	370	698	354	670	1238	686	1270	2318
26.8	80	176.0	193	380	716	360	680	1256	692	1280	2336
32.1	90	194.0	199	390	734	365	690	1274	697	1290	2354

Metric Conversion Table

Fraction	Inch	MM	Fraction	Inch	MM	Fraction	Inch	MM
1/64	0.0156	0.3969		0.2883	7.3228	11/16	0.6875	17.4625
	0.0250	0.6350	19/64	0.2969	7.5406	45/64	0.7031	17.8594
1/32	0.0312	0.7937	5/16	0.3125	7.9375		0.7087	18.0000
	0.0394	1.0000		0.3150	8.0000	23/32	0.7187	18.2562
	0.0400	1.0160	21/64	0.3281	8.3344	47/64	0.7344	18.6532
3/64	0.0469	1.1906	11/32	0.3437	8.7312		0.7435	18.8849
	0.0472	1.2000		0.3543	9.0000		0.7480	19.0000
	0.0550	1.3970	23/64	0.3594	9.1281	3/4	0.7500	19.0500
	0.0591	1.5000	3/8	0.3750	9.5250	49/64	0.7656	19.4469
1/16	0.0625	1.5875	25/64	0.3906	9.9213		0.7717	19.6012
	0.0709	1.8000		0.3937	10.0000	25/32	0.7812	19.8433
5/64	0.0781	1.9844	13/32	0.4062	10.3187		0.7874	20.0000
	0.0787	2.0000		0.4100	10.4140	51/64	0.7969	20.2402
	0.0906	2.3012	27/64	0.4219	10.7156	13/16	0.8125	20.6375
3/32	0.0937	2.3812		0.4250	10.7950		0.8268	21.0000
	0.0984	2.5000		0.4331	11.0000	53/64	0.8281	21.0344
	0.1000	2.5400	7/16	0.4375	11.1125	27/32	0.8437	21.4312
	0.1024	2.6000	29/64	0.4531	11.5094	55/64	0.8594	21.8281
7/64	0.1094	2.7781		0.4600	11.6840		0.8661	22.0000
	0.1100	2.7940	15/32	0.4687	11.9062	7/8	0.8750	22.2250
	0.1102	2.8000		0.4724	12.0000	57/64	0.8906	22.6219
	0.1181	3.0000	31/64	0.4844	12.3031		0.9055	23.0000
1/8	0.1250	3.1750	1/2	0.5000	12.7000	29/32	0.9062	23.0187
	0.1256	3.1902		0.5118	13.0000	59/64	0.9219	23.4156
	0.1378	3.5000	33/64	0.5156	13.0968	15/16	0.9375	23.8125
9/64	0.1406	3.5719	17/32	0.5312	13.4937		0.9449	24.0000
5/32	0.1562	3.9687	35/64	0.5469	13.8906	61/64	0.9531	24.2094
	0.1575	4.0000		0.5512	14.0000	31/32	0.9687	24.6062
11/64	0.1719	4.3656	9/16	0.5625	14.2875		0.9843	25.0000
3/16	0.1875	4.7625	37/64	0.5781	14.6844	63/64	0.9844	25.0031
	0.1892	4.8057		0.5906	15.0000		1.0000	25.4000
	0.1969	5.0000	19/32	0.5937	15.0812		1.0236	26.0000
13/64	0.2031	5.1594	39/64	0.6094	15.4781		1.0415	26.4541
	0.2165	5.4991	5/8	0.6250	15.8750		1.0480	26.6192
7/32	0.2187	5.5562		0.6299	16.0000	1-1/16	1.0625	26.9875
15/64	0.2344	5.9531	41/64	0.6406	16.2719		1.0630	27.0000
	0.2362	6.0000		0.6500	16.5100		1.1025	28.0000
1/4	0.2500	6.3500	21/32	0.6562	16.6687	1-1/8	1.1250	28.5750
17/64	0.2656	6.7469		0.6620	16.8148		1.1417	29.0000
	0.2756	7.0000		0.6693	17.0000		1.1812	30.0000
9/32	0.2812	7.1437	43/64	0.6719	17.0656	1-3/16	1.1875	30.1625
						1-1/4	1.2500	31.7500
						1-1/2	1.5000	38.1000

The Care and Handling of Precision Ball Bearings

NMB miniature ball bearings are high precision devices compared to many mechanical parts. Good performance will therefore require treatment that takes into account their characteristics and operating environment.

A high percentage of bearing problems, including failures, are the result of improper handling procedures. The following pages represent the results of our most common case studies. We hope you will find the information useful in the care and handling of precision ball bearings.

Particle Contamination

The performance of miniature precision ball bearings is critically affected by minute particle contamination. Particles as small as 0.005mm, once inside a bearing, can cause raceway scratches, abrasion and can decrease performance, shortened life and generate acoustic noise and vibration. Avoiding exposing the bearings to any environment where particles may be present is highly recommended.

Shields and seals are used to prevent contaminants from reaching the inside of the bearing. However, after assembly, there is still a small gap between the shield and the inner ring. This gap may permit particle entry. Please observe the following procedures carefully:



- Keep your bearings handling room as clean as possible.
- Do not remove the bearings from their packaging until just before use. If you move the bearings to a container, be sure the container is clean. The lid should be kept close, and it should be cleaned every day to prevent particle accumulation
- Never use a bearing that has been dropped. It may be brinelled (race track dented). In use, a brinelled bearing will generate a high level of acoustic noise.
- Before applying adhesive to a bearing, use a clean cloth dampened with an alcohol agent to clean oily materials such as anti-corrosion oil from the inner and outer rings. Do not saturate the cloth excessively with the cleaning agent. The liquid agent itself could leak into the bearing, carrying particles with it.
- When applying a lubricant to the outer circumference of a bearing, take care to make sure the lubricant is not contaminated. You might inadvertently transfer the contamination into the bearing.
- Never use an applicator that will leave contaminants on or near the bearings. A cotton swab, for instance, may leave small fibrous particles behind. We recommend a mechanical dispenser, many are available, or a clean room type of applicator.
- Do not handle bearings in a place where they could be directly exposed to outside air. Airborne contaminants include dust, dirt, and humidity.

Rust Contamination

Since bearings are metallic products, they rust easily. Their treatment requires certain precautions:

- When handling bearings, use finger caps, tweezers or gloves that do not generate cotton fibers.
- When using unprotected fingers to handle a bearing, first make sure they are clean and free from perspiration and dust. Apply a quality mineral oil to the fingertips before touching the bearing. Do not use hand cream, as it may induce rust.
- If a shaft is dirty on the surface, rust may gather between the shaft and the bearing after they are fitted. It is important to make sure that the shaft is free from finger prints, perspiration, dust and dirt.
- When handling bearings, choose a place that is dry and clean. Always place the bearing boxes on a shelf or a pallet. Avoid placing the boxes directly on the floor or other locations where moisture and dirt may be present.
- Avoid storing bearings near air conditioners and direct sunlight. Bearings may rust when placed near an air conditioner outlet, or any place where wind or sunlight can enter directly.
- A great temperature difference may cause condensation to form on the bearings. In colder climates, allow the bearings to reach room temperature before unpacking them.
- Store bearings in centrally heated and properly ventilated environments.

Varnish applied to a motor winding may also cause bearings to rust when the acid generated by varnish gas is absorbed into the grease of the bearing. Be sure to test for this condition, and be aware that changes in procedures, such as drying time changes, may affect this condition.

Mounting Bearings

When bearings are mounted incorrectly, the balls will cause brinelling on the raceway and undermine bearing performance and life. Brinelling (dents and abrasions to the raceway) as small as 0.1 micron in depth will have an adverse effect on acoustic noise levels as well as causing increased torque levels.

Several general rules apply to mounting bearings. When assembling a bearing with its shaft or housing, it is critical that no force be applied to the balls. When mounting a bearing to a shaft, always press the inner ring. When mounting it into a housing, press the outer ring. Never apply force to the outer ring when mounting to a shaft, or to the inner ring when mounting into a housing. And never apply a shock load in either case.

- When manually fitting a shaft into a bearing through its bore, do not force the shaft because it may cause brinelling to the bearing.
- After gluing a bearing to a housing using a guide through the bearing bore, take the guide out very carefully or it may cause brinelling to the bearing.
- When motors are being assembled, be aware that bearings may be attracted by the magnet and could slip from your fingers. To avoid this, hold the motor shaft in your palm, and cautiously insert the rotor. For automated assembly, use an air cylinder, and steadily operate the assembly.

Shock Forces

Bearings are easily affected by shock forces. In the case of NMB P/N L-940, for example, a shock force from a 100 gram weight at 4mm away could cause brinelling.

Brinelling could also occur when bearings are automatically pres-fitted to a rotor shaft, if the shaft and bearing bore are not kept accurately in line.

A typical example of shock causing brinelling is when motors are placed on a conveyor belt. As the motors moved through the conveyor, the movement causes the motors to hit the iron plate underneath the conveyor, resulting in shock which causes brinelling to the bearing. Holes made on the iron plate prevent this type of shock force to be generated.

Application Environment

The environment in which bearings are used will largely determine their life. Chlorine gas, ozone and other chemicals will shorten bearing life, as the grease will become contaminated relatively quickly.

Generally, grease life will fall by half with every 10°C to 15°C the ambient temperature increases. Therefore, it is critical to select the correct lubricant for the anticipated operating temperature.

If you have any questions concerning the care and handling of NMB's miniature precision ball bearings, please contact a member of our Applications Engineering staff.

Errors

All information, data and dimension tables in this catalog have been carefully compiled and thoroughly checked. However, no responsibility for possible errors or omissions can be assumed.

Changes

The company reserves the right to change specifications and other information included in this catalog without notice.



Additional Products From NMB

Small Motors

NMB's small motor products include a line of hybrid and permanent magnet stepper motors, as well as NMB's brush and brushless DC motors. The brush DC motor line is ideal for applications that require small size and excellent power output. The brushless DC line is perfect for applications where

Mechanical Bearing Assemblies

NMB's Miniature Precision Ball Bearings are the first component of a highly successful design of a mechanical bearing assembly. Machined components such as magnets, gears, molded and machine plastic parts, die cast parts and special materials are



the environment is sensitive to interference, battery powered equipment and clean room. Standard NMB hybrid and permanent magnet stepper motors are available, as well as many customizable features for your unique application.

For more information on our motor products, e-mail us at: motors@nmbtc.com

Cooling Fans

NMB offers a comprehensive line of more than 100 axial fans ranging in size from 25mm to 173mm. DC & AC Axial fans and blowers are designed to solve thermal management problems for our OEM customers. Producing over 100 million fans per year, NMB's focus is on total thermal management solutions. With three engineering centers for cooling fan design, our own vertical manufacturing process and a dedicated sales force we are committed to providing a quality solution for your cooling needs.

For more information on our cooling fans, e-mail us at: fans@nmbtc.com

designed and manufactured to work precisely with NMB precision ball bearings. Complex mechanical bearing assemblies are custom made to your design specifications, and are ideal for medical, office automation, and currency machines, as well as factory and lab automation applications.

For more information on our mechanical assembly products, e-mail us at: assemblies@nmbtc.com

Fan Trays

NMB's extensive selection of AC and DC cooling fans, as well as the latest range of high efficiency motorized impellers are your turn-key solution for your custom fan tray designs. NMB's fan tray product offerings include single or multiple devices, redundant and single-point of failure proof design, intelligent and self regulated control functions, two way communication with system for remote access and wide voltage range design.

For more information on our custom Fan Trays e-mail us at: info@nmbtc.com





ISO 14001 • ISO 9001:2008 • TS 16949 • OHSAS 18001

NMB Technologies Corporation

North America

Corporate Headquarters

9730 Independence Avenue

Chatsworth, CA 91311

P: 818-341-3355, F: 818-341-8207

E: info@nmbtc.com

www.nmbtc.com

Represented by:

International Sales Offices

Shanghai, China

Chennai, India

Bracknell, England

Baillet en France, France

Langen, Germany

Kowloon, Hong Kong

Milan, Italy

Tokyo, Japan

Kuala Lumpur, Malaysia

Manila, Philippines

Singapore

Seoul, South Korea

Taipei, Taiwan

Bangkok, Thailand

Hanoi, Vietnam